

TK-3118

SERVICE MANUAL / 维修手册

SUPPLEMENT / 追补版

This TK-3118 service manual contains a number of sections which differ from the service manual (B51-8576-00) for the TK-3118. For items other than those in this TK-3118 service manual please refer to the service manual (B51-8576-00) for the TK-3118.

本TK-3118维修手册记述了不同于TK-3118用维修手册（B51-8576-00）部分的内容。对于本TK-3118维修手册中未予记载的项目，请参阅TK-3118的维修手册（B51-8576-00）。



TK-3118

CONTENTS

GENERAL	2
PARTS LIST	3
EXPLODED VIEW	11
PACKING	12
ADJUSTMENT	13
PC BOARD VIEWS	
DISPLAY UNIT (X41-3583-00)	19
TX-RX UNIT (X57-6243-XX)	21
SCHEMATIC DIAGRAM	33
BLOCK DIAGRAM	37
LEVEL DIAGRAM	39
BC-20, PB-40, PB-41, BT-12	40
SPECIFICATIONS	41

概述	2	发射 – 接收单元 (X57-6243-XX)	21
零件表	3	原理图	33
部件分解图	11	方块图	37
包装	12	电平图	39
调整	13	BC-20, PB-40, PB-41, BT-12	40
PC板视图		规格	背面
显示单元 (X41-3583-00)	19		

GENERAL / 概述

INTRODUCTION

SCOPE OF THIS MANUAL

This manual is intended for use by experienced technicians familiar with similar types of commercial grade communications equipment. It contains all required service information for the equipment and is current as of the publication date. Changes which may occur after publication are covered by either Service Bulletins or Manual Revisions. These are issued as required.

ORDERING REPLACEMENT PARTS

When ordering replacement parts or equipment information, the full part identification number should be included. This applies to all parts : components, kits, or chassis. If the part number is not known, include the chassis or kit number of which it is a part, and a sufficient description of the required component for proper identification.

PERSONAL SAFETY

The following precautions are recommended for personal safety :

- DO NOT transmit until all RF connectors are verified secure and any open connectors are properly terminated.
- SHUT OFF and DO NOT operate this equipment near electrical blasting caps or in an explosive atmosphere.
- This equipment should be serviced by a qualified technician only.

SERVICE

This radio is designed for easy servicing. Refer to the schematic diagrams, printed circuit board views, and alignment procedures contained within.

Destination	Number of CH	RF power output
C, C4	50	5W/2W

引言

本手册的范围

本手册是提供给熟悉通信专业并且具有维修经验的技术人员使用的。它包括了维修该设备所需要的全部资料和现行出版日期。在出版后可能发生变动，如果需要，可以使用《维修通报》或《手册修订本》进行补充。

替换零件的订购

当订购替换零件或设备信息时，应注明完整的零件识别号码。所有的零件均有识别号码：元件、组件或机壳。如果不知道零件的号码，为了正确地识别，必须注明此元件所属的机壳或组件的号码，并对元件进行充分的说明。

个人安全

为了个人的安全，请注意下列事项：

- 在没有认真核实所有射频插头之前或有任何一个打开的插头没有连接到相应端子上的情况下，均不要发射。
- 在电爆管附近或在易燃性气体环境中，必须关掉电源，不要操作本设备。
- 本设备只应该由有资格的技术人员来维修。

维修服务

为了便于维修本设备，建立了完整的维修服务体系，提供了包括原理图、印刷线路板图和调整步骤在内的资料供参考。

型式	信道号码	射频功率输出
C, C4	50	5W/2W

PARTS LIST / 零件表

* New Parts. Δ indicates safety critical components.
 Parts without **Parts No.** are not supplied.
 Les articles non mentionnes dans le **Parts No.** ne sont pas fournis.
 Teile ohne **Parts No.** werden nicht geliefert.

TK-3118

TX-RX UNIT (X57-6243-XX)

Ref. No.	Address	New parts	Parts No.	Description	Destination	Ref. No.	Address	New parts	Parts No.	Description	Destination
TK-3118						TX-RX UNIT (X57-6243-XX) -00:C, -01:C4					
1	3A		A01-2173-11	CABINET(REAR)		R600-603			RK73GB1J221J	CHIP R 220 J 1/16W	
2	1A	*	A02-3559-13	CABINET ASSY(FORONT)		R604-606			RK73GB1J680J	CHIP R 68 J 1/16W	
3	3A		A62-0932-03	PANEL ASSY		31	2B		T91-0616-05	MIC ELEMENT	
4	3A		B09-0599-03	CAP		TX-RX UNIT (X57-6243-XX) -00:C, -01:C4					
5	1A		B10-2652-13	FRONT GLASS		32	2A		A13-1632-03	FRAME	
6	-		B62-1387-10	INSTRUCTION MANUAL		33	1A		B11-1268-04	FILTER(LCD)	
7	3A	*	B72-1886-14	MODEL NAME PLATE	C	34	1A		B11-1269-03	ILLUMINATION GUIDE(LCD)	
7	3A	*	B72-1890-14	MODEL NAME PLATE	C4	35	1A		B38-0848-05	LCD	
8	3A		E04-0430-05	RF COAXIAL RECEPTACLE(SMA)		D300			B30-2156-05	LED(RED)	
9	2B		E23-1148-04	BATT TERMINAL(-)		D304,305			B30-2143-05	LED(YG)	
10	2B		E23-1169-04	BATT TERMINAL(+)		D313			B30-2157-05	LED(YELLOW)	
11	2B		E23-1186-04	GROUND TERMINAL		C1			CK73HB1H471K	CHIP C 470PF K	
12	2B		F07-1839-03	COVER(FPC)		C2			C92-0576-05	CHIP-TAN 1.0UF 6.3WV	
13	3A		G11-2664-24	RUBBER SHEET(RF PCB)		C3			CK73GB1H471K	CHIP C 470PF K	
14	3A		G11-4031-14	RUBBER SHEET(VOLL,ENC)		C4			CK73GB1C473K	CHIP C 0.047UF K	
15	1A		G53-1521-04	PACKING(SP/MIC)		C5			C92-0507-05	CHIP-TAN 4.7UF 6.3WV	
16	-		H12-3088-05	PACKING FIXTURE		C6			CK73HB1H471K	CHIP C 470PF K	
17	-		H25-0085-04	PROTECTION BAG		C7			CC73HCH1H100D	CHIP C 10PF D	
18	-		H52-1720-02	ITEM CARTON CASE		C8			CK73GB1H102K	CHIP C 1000PF K	C4
19	2B		J19-5391-02	HOLDER(BATT TERMINAL)		C8			CK73GB1H472K	CHIP C 4700PF K	C
20	-		J29-0465-04	BELT HOOK ACCESSORY		C9			CK73GB1C104K	CHIP C 0.10UF K	
21	-		J61-0429-05	BAND ACCESSORY		C10			CK73HB1H471K	CHIP C 470PF K	
22	-		J69-0352-05	HANDSTRAP ACCESSORY		C11			CK73HB1H102K	CHIP C 1000PF K	
23	3A		K29-5442-03	KNOB(VOL)		C12			CK73HB1A104K	CHIP C 0.10UF K	
24	3A		K29-5443-03	KNOB(ENC)		C13			CC73HCH1H101J	CHIP C 100PF J	
25	1B		K29-9026-13	KEY TOP(DIAL SCAN)		C14			CC73HCH1H100D	CHIP C 10PF D	
26	3B		K29-9027-03	KNOB(PTT MONI)		C15			CK73GB1C104K	CHIP C 0.10UF K	C4
27	1B		K29-9028-13	KEY TOP(DTMF)		C15			CK73GB1C333K	CHIP C 0.033UF K	C
A	2B		N09-2282-05	TAPTITE SCREW(CABINET)		C16			CK73HB1H102K	CHIP C 1000PF K	
B	3A		N09-2377-05	SPECIAL SCREW(SMA)		C18			CK73GB1H471K	CHIP C 470PF K	
C	3A		N14-0582-14	CIRCULAR NUT(SMA)		C21			CC73HCH1H470J	CHIP C 47PF J	
D	3A		N14-0590-04	CIRCULAR NUT(VOL,ENC)		C25			C92-0001-05	CHIP-C 0.1UF 35WV	
E	1A		N38-2030-46	PAN HEAD MACHINE SCREW		C26			CK73HB1H331K	CHIP C 330PF K	
F	3A,3B		N80-2016-45	PAN HEAD TAPTITE SCREW		C27			CK73GB1H471K	CHIP C 470PF K	
G	2A		N83-2004-46	PAN HEAD TAPTITE SCREW		C28			CK73HB1H471K	CHIP C 470PF K	
H	-		N99-2023-05	SCREW SET ACCESSORY		C29			C92-0512-05	CHIP-TAN 1.0UF 16WV	
SP	1A		T07-0362-05	SPEAKER		C30			CK73HB1H221K	CHIP C 220PF K	
ANT	-		T90-0759-05	HELICAL ANTENNA	C	C32			C92-0560-05	CHIP-TAN 10UF 6.3WV	
ANT	-	*	T90-0760-05	HELICAL ANTENNA	C4	C33			CC73HCH1H150J	CHIP C 15PF J	
DISPLAY UNIT (X41-3583-00)						C34			CC73HCH1H020C	CHIP C 2.0PF C	
X41358B						C35			C92-0001-05	CHIP-C 0.1UF 35WV	
D100-107			B30-2157-05	LED(YELLOW)		C36			CK73HB1H471K	CHIP C 470PF K	
C600			CK73GB1H471K	CHIP C 470PF K		C40			CK73GB1H102K	CHIP C 1000PF K	
28	2B		E37-0865-05	SPEAKER CORD		C41			CC73HCH1H680J	CHIP C 68PF J	
30	2B		J30-1267-04	SPACER(ECM)		C42			C92-0560-05	CHIP-TAN 10UF 6.3WV	
R307-310			RK73GB1J102J	CHIP R 1.0K J 1/16W		C43			CC73HCH1H330J	CHIP C 33PF J	
			J82-0082-05	FPC		C44			CC73HCH1H121J	CHIP C 120PF J	
						C45			CC73HCH1H030C	CHIP C 3.0PF C	
						C46			CK73GB1H471K	CHIP C 470PF K	
						C47			CC73HCH1H330J	CHIP C 33PF J	
						C49			CC73HCH1H680J	CHIP C 68PF J	

PARTS LIST / 零件表

TX-RX UNIT (X57-6243-XX)

Ref. No.	Address	New parts	Parts No.	Description	Destination	Ref. No.	Address	New parts	Parts No.	Description	Destination
C50			CK73HB1H471K	CHIP C 470PF K		C122			CC73GCH1H080D	CHIP C 8.0PF D	C4
C51			C92-0560-05	CHIP-TAN 10UF 6.3WV		C125			CC73GCH1H050B	CHIP C 5.0PF B	C
C53			CK73GB1H103K	CHIP C 0.010UF K		C125			CC73GCH1H060B	CHIP C 6.0PF B	C4
C54			CK73GB1C104K	CHIP C 0.10UF K		C126			CK73GB1H471K	CHIP C 470PF K	
C59			CK73HB1H182K	CHIP C 1800PF K		C127			CC73GCH1H020B	CHIP C 2.0PF B	C
C60			CK73HB1H102K	CHIP C 1000PF K		C127			CC73GCH1H040B	CHIP C 4.0PF B	C4
C62,63			CK73HB1H471K	CHIP C 470PF K		C129			CK73GB1H471K	CHIP C 470PF K	
C64			CC73GCH1H080B	CHIP C 8.0PF B	C	C130			CC73GCH1HR75B	CHIP C 0.75PF B	
C64			CC73GCH1H200J	CHIP C 20PF J	C4	C131			CC73GCH1H050B	CHIP C 5.0PF B	C
C65			CC73GCH1H100C	CHIP C 10PF C	C4	C131			CC73GCH1H060B	CHIP C 6.0PF B	C4
C65			CC73GCH1H150J	CHIP C 15PF J	C	C133			CK73GB1C104K	CHIP C 0.10UF K	
C66			CC73GCH1H100C	CHIP C 10PF C	C	C134			CK73HB1H471K	CHIP C 470PF K	
C66			CC73GCH1H200J	CHIP C 20PF J	C4	C135			CC73GCH1H090B	CHIP C 9.0PF B	
C68			CC73GCH1H100C	CHIP C 10PF C	C4	C137			CK73GB1H471K	CHIP C 470PF K	
C68			CC73GCH1H120G	CHIP C 12PF G	C	C138			CK73HB1H471K	CHIP C 470PF K	
C69			CK73HB1H182K	CHIP C 1800PF K		C139			CC73GCH1HR75B	CHIP C 0.75PF B	
C70			CC73GCH1H270J	CHIP C 27PF J		C140			CC73GCH1H040B	CHIP C 4.0PF B	
C71			CC73HCH1H0R5B	CHIP C 0.5PF B		C141			CC73GCH1H050B	CHIP C 5.0PF B	C
C72			CC73GCH1H050B	CHIP C 5.0PF B	C	C141			CC73GCH1H060B	CHIP C 6.0PF B	C4
C72,73			CC73GCH1H050B	CHIP C 5.0PF B	C4	C145			CC73GCH1H470J	CHIP C 47PF J	C4
C73			CC73GCH1H030B	CHIP C 3.0PF B	C	C145			CC73GCH1H560J	CHIP C 56PF J	C
C74			CK73HB1H471K	CHIP C 470PF K		C146			CK73GB1H102K	CHIP C 1000PF K	C
C75			CC73GCH1H130J	CHIP C 13PF J		C147			CC73GCH1H471J	CHIP C 470PF J	
C77			CC73HCH1H030B	CHIP C 3.0PF B	C4	C149			CK73HB1H471K	CHIP C 470PF K	
C77			CK73HB1H471K	CHIP C 470PF K	C	C150			CK73GB1H471K	CHIP C 470PF K	
C78			CK73GB1C104K	CHIP C 0.10UF K	C	C151			C92-0565-05	CHIP-TAN 6.8UF 10WV	
C78			CK73GB1H561K	CHIP C 560PF K	C4	C152			CK73HB1H471K	CHIP C 470PF K	
C79			CC73GCH1H0R5B	CHIP C 0.5PF B		C154			CK73GB1H471K	CHIP C 470PF K	
C80			CC73HCH1H080D	CHIP C 8.0PF D		C159			CK73HB1H471K	CHIP C 470PF K	
C81			CC73GCH1H100C	CHIP C 10PF C		C162			CC73GCH1H390J	CHIP C 39PF J	C4
C82			CC73GCH1H0R5B	CHIP C 0.5PF B		C163			CK73HB1H471K	CHIP C 470PF K	
C83			CK73HB1H471K	CHIP C 470PF K		C164			CK73GB1H471K	CHIP C 470PF K	
C85-87			CK73HB1H471K	CHIP C 470PF K		C166-168			CK73GB1H471K	CHIP C 470PF K	
C88			CK73HB1C103K	CHIP C 0.010UF K		C169			CC73GCH1H050B	CHIP C 5.0PF B	C
C90			CC73HCH1H060B	CHIP C 6.0PF B	C	C169			CC73GCH1H060B	CHIP C 6.0PF B	C4
C90			CC73HCH1H080B	CHIP C 8.0PF B	C4	C170			CK73GB1H471K	CHIP C 470PF K	
C91			CK73HB1H471K	CHIP C 470PF K		C171			CK73FF1C105Z	CHIP C 1.0UF Z	C4
C92			CC73GCH1H090D	CHIP C 9.0PF D		C172			CK73HB1H471K	CHIP C 470PF K	
C93			CC73HCH1H220J	CHIP C 22PF J		C173			CC73GCH1HR75B	CHIP C 0.75PF B	
C95			CK73HB1H471K	CHIP C 470PF K		C174			CK73GB1H471K	CHIP C 470PF K	
C96			CK73HB1C103K	CHIP C 0.010UF K		C176			CK73GB1H103K	CHIP C 0.010UF K	
C97			C92-0507-05	CHIP-TAN 4.7UF 6.3WV		C177			CK73GB1H471K	CHIP C 470PF K	
C98-101			CK73HB1H471K	CHIP C 470PF K		C178			CC73GCH1H050B	CHIP C 5.0PF B	C
C102			CK73HB1H102K	CHIP C 1000PF K		C178			CC73GCH1H060B	CHIP C 6.0PF B	C4
C103			CC73HCH1H030C	CHIP C 3.0PF C	C	C179			CC73GCH1H150G	CHIP C 15PF G	C
C103			CC73HCH1H060B	CHIP C 6.0PF B	C4	C180			CK73GB1C104K	CHIP C 0.10UF K	
C104			CK73HB1H471K	CHIP C 470PF K		C182			CC73GCH1HR75B	CHIP C 0.75PF B	
C105			CC73HCH1H150J	CHIP C 15PF J	C	C183			CC73GCH1H1R5B	CHIP C 1.5PF B	C4
C105			CC73HCH1H180J	CHIP C 18PF J	C4	C185			CC73GCH1H100D	CHIP C 10PF D	
C107			CK73HB1H471K	CHIP C 470PF K		C186			CC73GCH1H270G	CHIP C 27PF G	C
C109			CK73HB1C103K	CHIP C 0.010UF K		C186			CC73GCH1H430J	CHIP C 43PF J	C4
C111			CK73HB1H471K	CHIP C 470PF K		C187			CK73GB1H471K	CHIP C 470PF K	
C112			CC73GCH1H100C	CHIP C 10PF C		C189			CC73HCH1H101J	CHIP C 100PF J	
C116			CK73HB1H471K	CHIP C 470PF K		C190			CK73GB1H471K	CHIP C 470PF K	
C121			CK73HB1H471K	CHIP C 470PF K		C192			CK73GB1H471K	CHIP C 470PF K	
C122			CC73GCH1H050B	CHIP C 5.0PF B	C	C193			CC73GCH1H060B	CHIP C 6.0PF B	

PARTS LIST / 零件表

TX-RX UNIT (X57-6243-XX)

Ref. No.	Address	New parts	Parts No.	Description	Destination	Ref. No.	Address	New parts	Parts No.	Description	Destination
C194			CC73GCH1H101J	CHIP C 100PF J	C4	C318			C92-0560-05	CHIP-TAN 10UF 6.3WV	
C194			CC73GCH1H270G	CHIP C 27PF G	C	C319-321			CK73HB1H471K	CHIP C 470PF K	
C197			CK73GB1H471K	CHIP C 470PF K		C322			CK73GB1H471K	CHIP C 470PF K	
C198			CC73GCH1H090B	CHIP C 9.0PF B	C	C323			CK73EF1C105Z	CHIP C 1.0UF Z	
C198			CC73GCH1H3R5B	CHIP C 3.5PF B	C4	C324			C92-0623-05	CHIP-TAN 22UF 4WV	
C199			CC73GCH1H471J	CHIP C 470PF J		C326			CK73HB1C223K	CHIP C 0.022UF K	
C200			CK73HB1H102K	CHIP C 1000PF K		C327			CK73GB1C273K	CHIP C 0.027UF K	
C201			CC73GCH1H020B	CHIP C 2.0PF B		C328			CK73HB1H471K	CHIP C 470PF K	
C202			CK73HB1H102K	CHIP C 1000PF K		C329			CK73GB1C273K	CHIP C 0.027UF K	
C203			CC73GCH1H020B	CHIP C 2.0PF B		C331			CK73HB1H471K	CHIP C 470PF K	
C204			CC73GCH1H050B	CHIP C 5.0PF B		C332			CK73FB1A105K	CHIP C 1.0UF K	
C205			CC73GCH1H1R5B	CHIP C 1.5PF B		C333			CK73HB1H102K	CHIP C 1000PF K	
C206			CK73HB1H471K	CHIP C 470PF K		C334			CK73FB1A105K	CHIP C 1.0UF K	
C207			CC73GCH1H040B	CHIP C 4.0PF B		C335			CK73HB1A393K	CHIP C 0.039UF K	
C208			CC73GCH1H3R5B	CHIP C 3.5PF B	C4	C336			CK73GB1C104K	CHIP C 0.10UF K	
C212			CK73GB1H102K	CHIP C 1000PF K	C	C337			CK73FB1A105K	CHIP C 1.0UF K	
C212			CK73GB1H471K	CHIP C 470PF K	C4	C338			CK73FF1E104Z	CHIP C 0.10UF Z	
C213			CK73HB1H471K	CHIP C 470PF K		C339			CK73FF1C105Z	CHIP C 1.0UF Z	
C214			CK73HB1H102K	CHIP C 1000PF K		C343,344			CK73FB1A105K	CHIP C 1.0UF K	
C215			CC73HCH1H110J	CHIP C 11PF J	C	C347			CK73FB1A105K	CHIP C 1.0UF K	
C215			CC73HCH1H130G	CHIP C 13PF G	C4	C349,350			CK73HB1A104K	CHIP C 0.10UF K	
C216			CC73HCH1H070B	CHIP C 7.0PF B	C	C352			CK73HB1H392K	CHIP C 3900PF K	
C216			CC73HCH1H100C	CHIP C 10PF C	C4	C353			CK73HB1C103K	CHIP C 0.010UF K	
C217			CK73HB1H102K	CHIP C 1000PF K		C354			CK73HB1A683K	CHIP C 0.068UF K	
C218			CK73FF1C105Z	CHIP C 1.0UF Z		C356			CK73HB1A473K	CHIP C 0.047UF K	
C219			CC73GCH1H010C	CHIP C 1.0PF C		C357			CK73HB1C103K	CHIP C 0.010UF K	
C221,222			CK73HB1H471K	CHIP C 470PF K		C358			CK73HB1E682K	CHIP C 6800PF K	
C223			CC73GCH1H050B	CHIP C 5.0PF B	C	C359			C92-0587-05	CHIP-TAN 2.2UF 4WV	
C223			CC73GCH1H060B	CHIP C 6.0PF B	C4	C360			CK73HB1A473K	CHIP C 0.047UF K	
C224			CK73HB1H471K	CHIP C 470PF K		C361			CK73HB1C103K	CHIP C 0.010UF K	
C225			CC73GCH1H470J	CHIP C 47PF J	C	C362			CK73GB1H682K	CHIP C 6800PF K	
C226			CC73GCH1H070B	CHIP C 7.0PF B		C363			CK73HB1A333K	CHIP C 0.033UF K	
C230,231			CK73HB1H471K	CHIP C 470PF K		C365			CK73HB1H392K	CHIP C 3900PF K	
C232			CK73GB1H471K	CHIP C 470PF K		C366			CK73GB1H472K	CHIP C 4700PF K	
C234			CK73GB1H471K	CHIP C 470PF K		C367			CK73HB1C103K	CHIP C 0.010UF K	
C236			CC73GCH1H040B	CHIP C 4.0PF B	C4	C369			CK73FB1A105K	CHIP C 1.0UF K	
C236			CC73GCH1H2R5B	CHIP C 2.5PF B	C	C370			CK73HB1H392K	CHIP C 3900PF K	
C237			CC73GCH1H0R5B	CHIP C 0.5PF B		C371			CK73HB1A104K	CHIP C 0.10UF K	
C238			CK73GB1H471K	CHIP C 470PF K		C374			CK73GB1C104K	CHIP C 0.10UF K	
C240			CC73GCH1H160G	CHIP C 16PF G	C	C375			CK73HB1H471K	CHIP C 470PF K	
C240			CC73GCH1H240G	CHIP C 24PF G	C4	C376			C92-0560-05	CHIP-TAN 10UF 6.3WV	
C242			CC73GCH1H330G	CHIP C 33PF G	C4	C377			CK73GB1H391K	CHIP C 390PF K	
C243			CC73HCH1H150J	CHIP C 15PF J	C4	C378			CK73HB1E682K	CHIP C 6800PF K	
C244			CC73HCH1H101J	CHIP C 100PF J		C381			CK73HB1A473K	CHIP C 0.047UF K	
C300			CK73HB1H332K	CHIP C 3300PF K		C382			CK73HB1H332K	CHIP C 3300PF K	
C301			CK73HB1A473K	CHIP C 0.047UF K		C383			CK73HB1A104K	CHIP C 0.10UF K	
C302			CC73HCH1H390J	CHIP C 39PF J		C384			C92-0560-05	CHIP-TAN 10UF 6.3WV	
C303-305			CK73HB1H471K	CHIP C 470PF K		C385			CC73HCH1H100D	CHIP C 10PF D	
C306			CC73HCH1H390J	CHIP C 39PF J		C386			C92-0560-05	CHIP-TAN 10UF 6.3WV	
C307-309			CK73HB1C103K	CHIP C 0.010UF K		C387			CK73HB1H471K	CHIP C 470PF K	
C310			CC73HCH1H100D	CHIP C 10PF D		C388			CK73GB1H102K	CHIP C 1000PF K	
C311,312			CK73HB1H471K	CHIP C 470PF K		C389			CC73HCH1H560J	CHIP C 56PF J	
C313			CC73HCH1H030C	CHIP C 3.0PF C		C390			CK73HB1A333K	CHIP C 0.033UF K	
C314			CHIP C 10PF D			C391			CK73HB1C223K	CHIP C 0.022UF K	
C316			CK73HB1H471K	CHIP C 470PF K		C392			CK73HB1A473K	CHIP C 0.047UF K	
C317			CK73HB1A104K	CHIP C 0.10UF K		C393			C92-0507-05	CHIP-TAN 4.7UF 6.3WV	

PARTS LIST / 零件表

TX-RX UNIT (X57-6243-XX)

Ref. No.	Address	New parts	Parts No.	Description	Destination	Ref. No.	Address	New parts	Parts No.	Description	Destination
C394			CK73HB1A683K	CHIP C 0.068UF K		L11			L40-1875-92	SMALL FIXED INDUCTOR(18NH)	
C395			CK73HB1H102K	CHIP C 1000PF K		L12,13			L40-2285-92	SMALL FIXED INDUCTOR(220NH)	
C396			CK73HB1H221K	CHIP C 220PF K		L14-16			L92-0140-05	FERRITE CHIP	
C397			CK73HB1H471K	CHIP C 470PF K		L17			L40-6891-86	SMALL FIXED INDUCTOR(6.8UH)	
C398			CK73HB1A104K	CHIP C 0.10UF K		L18			L92-0140-05	FERRITE CHIP	
C399			CK73GB1E393J	CHIP C 0.039UF J		L20			L40-2278-98	SMALL FIXED INDUCTOR(22NH)	C4
C400,401			CK73GB1C104K	CHIP C 0.10UF K		L20,21			L40-2278-98	SMALL FIXED INDUCTOR(22NH)	C
C402			CK73HB1H471K	CHIP C 470PF K		L21			L40-2778-98	SMALL FIXED INDUCTOR(27NH)	C4
C403			C92-0587-05	CHIP-TAN 2.2UF 4WV		L22			L34-4554-05	COIL	
C404			CK73GB1A474K	CHIP C 0.47UF K		L23			L40-6891-86	SMALL FIXED INDUCTOR(6.8UH)	
C405			CK73FB1C474K	CHIP C 0.47UF K		L24			L92-0140-05	FERRITE CHIP	
C406			CC73GCH1H101J	CHIP C 100PF J		L25			L40-2775-92	SMALL FIXED INDUCTOR(27NH)	C
C407			C92-0560-05	CHIP-TAN 10UF 6.3WV		L25			L40-3375-92	SMALL FIXED INDUCTOR(33NH)	C4
C408			CK73GB1C104K	CHIP C 0.10UF K		L26			L40-4775-92	SMALL FIXED INDUCTOR(47NH)	
C409,410			CK73GB1H471K	CHIP C 470PF K		L27			L92-0140-05	FERRITE CHIP	
C411			CK73GB1C473K	CHIP C 0.047UF K		L28			L40-4785-85	SMALL FIXED INDUCTOR(0.47UH)	
C412			C92-0560-05	CHIP-TAN 10UF 6.3WV		L29			L40-2775-92	SMALL FIXED INDUCTOR(27NH)	C
C413			CK73GB1H103K	CHIP C 0.010UF K		L29			L40-3375-92	SMALL FIXED INDUCTOR(33NH)	C4
C414			C92-0665-05	TANTAL 100UF 6.3WV		L30			L40-3385-85	SMALL FIXED INDUCTOR(0.33UH)	
C416			CK73HB1H471K	CHIP C 470PF K		L31			L40-6875-92	SMALL FIXED INDUCTOR(68NH)	
C418			CC73GCH1H221J	CHIP C 220PF J		L33			L40-1875-92	SMALL FIXED INDUCTOR(18NH)	C
C420			CK73HB1H102K	CHIP C 1000PF K		L33			L40-6865-92	SMALL FIXED INDUCTOR(6.8NH)	C4
C421			CK73HB1H471K	CHIP C 470PF K		L34,35			L40-1278-60	SMALL FIXED INDUCTOR(12NH)	
C422			CK73HB1H102K	CHIP C 1000PF K		L36			L40-1275-92	SMALL FIXED INDUCTOR(12NH)	
C423			CK73HB1A473K	CHIP C 0.047UF K		L37			L92-0140-05	FERRITE CHIP	
C424			CK73GB1H561K	CHIP C 560PF K		L38			L41-4778-03	SMALL FIXED INDUCTOR	C
TC1			C05-0383-05	CERAMIC TRIMMER CAP(6PF)	C	L38			L41-5678-03	SMALL FIXED INDUCTOR	C4
TC1,2			C05-0384-05	CERAMIC TRIMMER CAP(10PF)	C4	L39			L40-1278-60	SMALL FIXED INDUCTOR(12NH)	
TC2			C05-0384-05	CERAMIC TRIMMER CAP(10PF)	C	L40			L41-2278-03	SMALL FIXED INDUCTOR	C
TC3			C05-0383-05	CERAMIC TRIMMER CAP(6PF)		L40			L41-4778-03	SMALL FIXED INDUCTOR	C4
TC5			C05-0383-05	CERAMIC TRIMMER CAP(6PF)	C4	L42			L40-1098-76	SMALL FIXED INDUCTOR(1UH)	C
TC5			C05-0384-05	CERAMIC TRIMMER CAP(10PF)	C	L42			L40-4788-76	SMALL FIXED INDUCTOR(0.47UH)	C4
						L43			L92-0149-05	FERRITE CHIP	
36	1A		E29-1190-04	INTER CONNECTOR(LCD)		L44			L40-1078-60	SMALL FIXED INDUCTOR(10NH)	C
37	2A	*	E37-0996-05	FLAT CABLE		L44			L40-1278-60	SMALL FIXED INDUCTOR(12NH)	C4
CN1			E40-5651-05	FLAT CABLE CONNECTOR							
CN2			E23-0603-05	RELAY TERMINAL(ANT)		L45			L34-4568-05	AIR-CORE COIL	
CN3-6		*	E23-1214-05	TERMINAL(FINAL FET)		L46			L92-0149-05	FERRITE CHIP	
						L47			L40-1278-60	SMALL FIXED INDUCTOR(12NH)	
CN100			E40-5630-05	PIN ASSY SOCKET		L48			L41-1578-03	SMALL FIXED INDUCTOR	C4
CN301			E40-5651-05	FLAT CABLE CONNECTOR		L48,49			L41-1578-03	SMALL FIXED INDUCTOR	C
CN302			E40-5629-05	PIN ASSY							
CN303			E40-6166-05	FLAT CABLE CONNECTOR		L49			L41-1078-03	SMALL FIXED INDUCTOR	C4
J300			E11-0457-05	PHONE JACK		L50			L40-2285-54	SMALL FIXED INDUCTOR(220NH)	
						L51			L34-4564-05	AIR-CORE COIL	
W1		*	E37-0860-05	PROCESSED LEAD WIRE	C4	L52			L34-4563-05	AIR-CORE COIL	
						L53			L34-4564-05	AIR-CORE COIL	
F1			F53-0217-05	FUSE							
						L54			L34-4563-05	AIR-CORE COIL	
38	2A	*	G11-4126-04	SHEET		L55			L40-1092-81	SMALL FIXED INDUCTOR	
						L57			L40-6865-92	SMALL FIXED INDUCTOR(6.8NH)	
39	1A		J21-8412-14	HARDWARE FIXTURE		L58			L40-6891-86	SMALL FIXED INDUCTOR(6.8UH)	
						L59			L92-0140-05	FERRITE CHIP	
CF1			L72-0958-05	CERAMIC FILTER							
L1			L92-0140-05	FERRITE CHIP		L60			L40-6891-86	SMALL FIXED INDUCTOR(6.8UH)	
L2-4			L92-0138-05	FERRITE CHIP		L63			L40-2775-92	SMALL FIXED INDUCTOR(27NH)	C
L5			L40-1005-85	SMALL FIXED INDUCTOR(10UH)		L64			L34-4563-05	AIR-CORE COIL	C4
L6,7			L92-0138-05	FERRITE CHIP		L300,301			L40-2281-86	SMALL FIXED INDUCTOR(0.22UH)	
						L302			L92-0138-05	FERRITE CHIP	
L9			L40-5681-86	SMALL FIXED INDUCTOR(0.56UH)							
L10			L40-4781-86	SMALL FIXED INDUCTOR(0.47UH)		L303			L40-2281-86	SMALL FIXED INDUCTOR(0.22UH)	

PARTS LIST / 零件表

TX-RX UNIT (X57-6243-XX)

Ref. No.	Address	New parts	Parts No.	Description	Destination	Ref. No.	Address	New parts	Parts No.	Description	Destination
L304,305			L92-0140-05	FERRITE CHIP		R54			RK73HB1J332J	CHIP R 3.3K J 1/16W	
L306			L92-0149-05	FERRITE CHIP		R55			RK73GB1J561J	CHIP R 560 J 1/16W	
L307-309			L92-0138-05	FERRITE CHIP		R56			RK73HB1J470J	CHIP R 47 J 1/16W	
X1			L77-1792-05	TCXO (12.8MHZ)		R57			RK73HB1J100J	CHIP R 10 J 1/16W	
X300			L77-1761-05	CRYSTAL RESONATOR(7.3728MHZ)		R58			RK73HB1J102J	CHIP R 1.0K J 1/16W	C
X301			L78-0326-05	RESONATOR (4.19MHZ)		R58			RK73HB1J821J	CHIP R 820 J 1/16W	C4
XF1			L71-0586-05	MCF (38.85MHZ)		R59			RK73HB1J332J	CHIP R 3.3K J 1/16W	
CP302			R90-0718-05	MULTI-COMP 4.7K X4		R60			RK73HB1J181J	CHIP R 180 J 1/16W	
R1			RK73HB1J472J	CHIP R 4.7K J 1/16W		R61			RK73HB1J102J	CHIP R 1.0K J 1/16W	
R2			RK73HB1J273J	CHIP R 27K J 1/16W		R62			R92-1368-05	CHIP R 0 OHM	
R3			R92-1252-05	CHIP R 0 OHM J 1/16W		R63			R92-1252-05	CHIP R 0 OHM J 1/16W	
R4			RK73HB1J563J	CHIP R 56K J 1/16W		R64			RK73HB1J473J	CHIP R 47K J 1/16W	
R5			RK73HB1J100J	CHIP R 10 J 1/16W		R65			RK73HB1J562J	CHIP R 5.6K J 1/16W	
R6			R92-1368-05	CHIP R 0 OHM		R67,68			RK73HB1J473J	CHIP R 47K J 1/16W	
R7			RK73HB1J222J	CHIP R 2.2K J 1/16W		R69			RK73HB1J181J	CHIP R 180 J 1/16W	
R8			RK73HB1J470J	CHIP R 47 J 1/16W		R70			RK73HB1J102J	CHIP R 1.0K J 1/16W	C
R9			RK73HB1J274J	CHIP R 270K J 1/16W		R72			RK73HB1J330J	CHIP R 33 J 1/16W	
R10			RK73HB1J222J	CHIP R 2.2K J 1/16W		R75			RK73HB1J152J	CHIP R 1.5K J 1/16W	C4
R11			RK73HB1J334J	CHIP R 330K J 1/16W		R77			RK73HB1J104J	CHIP R 100K J 1/16W	
R12,13			RK73HB1J561J	CHIP R 560 J 1/16W		R78			RK73HB1J332J	CHIP R 3.3K J 1/16W	C4
R14			RK73HB1J272J	CHIP R 2.7K J 1/16W		R78			RK73HB1J822J	CHIP R 8.2K J 1/16W	C
R15			RK73HB1J222J	CHIP R 2.2K J 1/16W		R79			RK73GB1J100J	CHIP R 10 J 1/16W	C4
R16			RK73HB1J102J	CHIP R 1.0K J 1/16W		R79			RK73GB1J220J	CHIP R 22 J 1/16W	C
R17			R92-1368-05	CHIP R 0 OHM		R80			RK73GB1J102J	CHIP R 1.0K J 1/16W	
R18			RK73GB1J101J	CHIP R 100 J 1/16W		R81			RK73HB1J104J	CHIP R 100K J 1/16W	
R19			RK73HB1J104J	CHIP R 100K J 1/16W		R83			R92-1252-05	CHIP R 0 OHM J 1/16W	
R20			RK73HB1J103J	CHIP R 10K J 1/16W		R84			R92-1368-05	CHIP R 0 OHM	C
R21			RK73HB1J101J	CHIP R 100 J 1/16W		R85			RK73HB1J104J	CHIP R 100K J 1/16W	
R22			RK73HB1J473J	CHIP R 47K J 1/16W		R88			RK73GB1J122J	CHIP R 1.2K J 1/16W	
R23			RK73HB1J103J	CHIP R 10K J 1/16W		R89			RK73GB1J683J	CHIP R 68K J 1/16W	
R25			RK73GB1J100J	CHIP R 10 J 1/16W		R90			RK73HB1J101J	CHIP R 100 J 1/16W	
R26			RK73HB1J104J	CHIP R 100K J 1/16W		R91			RK73GB1J152J	CHIP R 1.5K J 1/16W	C
R28			RK73HB1J122J	CHIP R 1.2K J 1/16W		R91			RK73GB1J471J	CHIP R 470 J 1/16W	C4
R29			RK73GB1J103J	CHIP R 10K J 1/16W		R92			RK73HB1J562J	CHIP R 5.6K J 1/16W	C4
R30			RK73HB1J332J	CHIP R 3.3K J 1/16W		R92			RK73HB1J821J	CHIP R 820 J 1/16W	C
R31			RK73HB1J472J	CHIP R 4.7K J 1/16W		R96			R92-1368-05	CHIP R 0 OHM	
R32			RK73HB1J153J	CHIP R 15K J 1/16W		R97			RK73HB1J121J	CHIP R 120 J 1/16W	
R33			RK73HB1J473J	CHIP R 47K J 1/16W		R98			RK73HB1J224J	CHIP R 220K J 1/16W	
R34			RK73HB1J154J	CHIP R 150K J 1/16W		R99			RK73GB1J273J	CHIP R 27K J 1/16W	C4
R36			RK73HB1J102J	CHIP R 1.0K J 1/16W	C	R99			RK73GB1J473J	CHIP R 47K J 1/16W	C
R36,37			RK73HB1J102J	CHIP R 1.0K J 1/16W	C4	R101			RK73GB1J823J	CHIP R 82K J 1/16W	
R37			RK73HB1J681J	CHIP R 680 J 1/16W	C	R102			R92-1252-05	CHIP R 0 OHM J 1/16W	
R38,39			RK73HB1J181J	CHIP R 180 J 1/16W		R103			RK73HB1J153J	CHIP R 15K J 1/16W	
R40			RK73HB1J102J	CHIP R 1.0K J 1/16W		R105			RK73HB1J104J	CHIP R 100K J 1/16W	
R41,42			RK73HB1J101J	CHIP R 100 J 1/16W		R106			RK73GB1J470J	CHIP R 47 J 1/16W	
R43			RK73HB1J124J	CHIP R 120K J 1/16W		R108			RK73GB1J102J	CHIP R 1.0K J 1/16W	
R44			RK73HB1J472J	CHIP R 4.7K J 1/16W		R110			RK73EB2ER39K	CHIP R 0.39 K 1/4W	
R45			RK73HB1J124J	CHIP R 120K J 1/16W		R112			RK73HB1J104J	CHIP R 100K J 1/16W	
R46			RK73HB1J104J	CHIP R 100K J 1/16W		R113,114			RK73EB2ER39K	CHIP R 0.39 K 1/4W	
R47			RK73GB1J561J	CHIP R 560 J 1/16W		R115			RK73HB1J104J	CHIP R 100K J 1/16W	
R48			RK73HB1J101J	CHIP R 100 J 1/16W		R116,117			RK73GH1J154D	CHIP R 150K D 1/16W	
R49			RK73HB1J102J	CHIP R 1.0K J 1/16W		R118			RK73HB1J104J	CHIP R 100K J 1/16W	
R50			RK73HB1J332J	CHIP R 3.3K J 1/16W		R119-122			RK73GH1J154D	CHIP R 150K D 1/16W	
R51			RK73HB1J562J	CHIP R 5.6K J 1/16W		R123			R92-0670-05	CHIP R 0 OHM	C
R52			RK73HB1J271J	CHIP R 270 J 1/16W		R124,125			RK73GB1J271J	CHIP R 270 J 1/16W	
R53			RK73HB1J103J	CHIP R 10K J 1/16W		R126			RK73GB1J103J	CHIP R 10K J 1/16W	

PARTS LIST / 零件表

TX-RX UNIT (X57-6243-XX)

Ref. No.	Address	New parts	Parts No.	Description	Destination	Ref. No.	Address	New parts	Parts No.	Description	Destination
R127			RK73HB1J273J	CHIP R 27K J 1/16W		R351			RK73HB1J224J	CHIP R 220K J 1/16W	
R128			RK73GB1J102J	CHIP R 1.0K J 1/16W		R352			RK73HB1J104J	CHIP R 100K J 1/16W	
R129			RK73HB1J563J	CHIP R 56K J 1/16W		R353			RK73HB1J472J	CHIP R 4.7K J 1/16W	
R130			RK73HB1J105J	CHIP R 1.0M J 1/16W		R354			RK73HB1J102J	CHIP R 1.0K J 1/16W	
R135			R92-1252-05	CHIP R 0 OHM J 1/16W		R356			RK73HB1J103J	CHIP R 10K J 1/16W	
R137			RK73HB1J102J	CHIP R 1.0K J 1/16W		R357			RK73HB1J682J	CHIP R 6.8K J 1/16W	
R138			R92-1252-05	CHIP R 0 OHM J 1/16W	C4	R358			RK73HB1J472J	CHIP R 4.7K J 1/16W	
R144			RK73GB1J102J	CHIP R 1.0K J 1/16W		R359			RK73HB1J561J	CHIP R 560 J 1/16W	
R145,146			RK73HB1J104J	CHIP R 100K J 1/16W		R360			RK73HB1J823J	CHIP R 82K J 1/16W	
R151			RK73GB1J333J	CHIP R 33K J 1/16W		R361			RK73HB1J103J	CHIP R 10K J 1/16W	
R152			R92-0670-05	CHIP R 0 OHM		R362			RK73HB1J333J	CHIP R 33K J 1/16W	
R153			RK73HB1J101J	CHIP R 100 J 1/16W		R363			RK73HB1J102J	CHIP R 1.0K J 1/16W	
R154			R92-1368-05	CHIP R 0 OHM		R364			RK73HB1J272J	CHIP R 2.7K J 1/16W	
R155-158			RK73HB1J103J	CHIP R 10K J 1/16W		R365			RK73HB1J332J	CHIP R 3.3K J 1/16W	
R300			RK73GB1J103J	CHIP R 10K J 1/16W		R366			RK73HB1J103J	CHIP R 10K J 1/16W	
R301			RK73HB1J103J	CHIP R 10K J 1/16W		R367			RK73HB1J332J	CHIP R 3.3K J 1/16W	
R302			RK73HB1J473J	CHIP R 47K J 1/16W		R368			RK73HB1J103J	CHIP R 10K J 1/16W	
R303			RK73HB1J103J	CHIP R 10K J 1/16W		R369			R92-1368-05	CHIP R 0 OHM	
R304			RK73HB1J102J	CHIP R 1.0K J 1/16W		R370			RK73HB1J102J	CHIP R 1.0K J 1/16W	
R305			RK73HB1J331J	CHIP R 330 J 1/16W		R371			RK73GB1J272J	CHIP R 2.7K J 1/16W	
R306			RK73HB1J100J	CHIP R 10 J 1/16W		R372			RK73HB1J471J	CHIP R 470 J 1/16W	
R307			RK73HB1J564J	CHIP R 560K J 1/16W		R373			RK73HB1J272J	CHIP R 2.7K J 1/16W	
R308			RK73HB1J472J	CHIP R 4.7K J 1/16W		R374			RK73GB1J821J	CHIP R 820 J 1/16W	
R309			RK73GB1J272J	CHIP R 2.7K J 1/16W		R375			R92-1368-05	CHIP R 0 OHM	
R311			RK73HB1J103J	CHIP R 10K J 1/16W		R376			RK73GB1J333J	CHIP R 33K J 1/16W	
R312			R92-1368-05	CHIP R 0 OHM		R377			RK73GB1J823J	CHIP R 82K J 1/16W	
R313			RK73HB1J104J	CHIP R 100K J 1/16W		R378			RK73HB1J473J	CHIP R 47K J 1/16W	
R314-317			RK73HB1J102J	CHIP R 1.0K J 1/16W		R379			RK73HB1J683J	CHIP R 68K J 1/16W	
R318			RK73HB1J104J	CHIP R 100K J 1/16W		R380			RK73GB1J821J	CHIP R 820 J 1/16W	
R319-321			RK73HB1J102J	CHIP R 1.0K J 1/16W		R381			RK73HB1J223J	CHIP R 22K J 1/16W	
R322			RK73HB1J104J	CHIP R 100K J 1/16W		R382			RK73HB1J332J	CHIP R 3.3K J 1/16W	
R323			RK73HB1J103J	CHIP R 10K J 1/16W		R383,384			R92-1368-05	CHIP R 0 OHM	
R324			RK73GB1J272J	CHIP R 2.7K J 1/16W		R385			RK73HB1J105J	CHIP R 1.0M J 1/16W	
R325			RK73HB1J100J	CHIP R 10 J 1/16W		R386			RK73HB1J562J	CHIP R 5.6K J 1/16W	
R326			RK73HB1J103J	CHIP R 10K J 1/16W		R387			RK73HB1J392J	CHIP R 3.9K J 1/16W	
R327,328			RK73HB1J221J	CHIP R 220 J 1/16W		R388			RK73HB1J124J	CHIP R 120K J 1/16W	
R329			RK73HB1J223J	CHIP R 22K J 1/16W		R389			RK73HB1J102J	CHIP R 1.0K J 1/16W	
R330			RK73HB1J104J	CHIP R 100K J 1/16W		R390			RK73GH1J913D	CHIP R 91K D 1/16W	
R331			RK73HB1J222J	CHIP R 2.2K J 1/16W		R391			RK73HB1J393J	CHIP R 39K J 1/16W	
R332			RK73HB1J104J	CHIP R 100K J 1/16W		R392			RK73HB1J102J	CHIP R 1.0K J 1/16W	
R333			RK73HB1J473J	CHIP R 47K J 1/16W		R393			RK73HB1J222J	CHIP R 2.2K J 1/16W	
R334,335			RK73HB1J102J	CHIP R 1.0K J 1/16W		R394			RK73HB1J183J	CHIP R 18K J 1/16W	
R336			RK73HB1J473J	CHIP R 47K J 1/16W		R395			RK73HB1J274J	CHIP R 270K J 1/16W	
R337			RK73HB1J153J	CHIP R 15K J 1/16W		R396			RK73HB1J333J	CHIP R 33K J 1/16W	
R338			RK73HB1J334J	CHIP R 330K J 1/16W		R397,398			RK73HB1J474J	CHIP R 470K J 1/16W	
R339,340			RK73GB1J221J	CHIP R 220 J 1/16W		R399			RK73HB1J274J	CHIP R 270K J 1/16W	
R341			RK73HB1J102J	CHIP R 1.0K J 1/16W		R400			RK73HB1J332J	CHIP R 3.3K J 1/16W	
R342			RK73HB1J684J	CHIP R 680K J 1/16W		R401			RK73HB1J683J	CHIP R 68K J 1/16W	
R343			RK73HB1J473J	CHIP R 47K J 1/16W		R402,403			RK73HB1J563J	CHIP R 56K J 1/16W	
R344			RK73HB1J100J	CHIP R 10 J 1/16W		R404			RK73HB1J332J	CHIP R 3.3K J 1/16W	
R345			RK73HB1J333J	CHIP R 33K J 1/16W		R405			RK73HB1J153J	CHIP R 15K J 1/16W	
R346			RK73HB1J334J	CHIP R 330K J 1/16W		R406			R92-1368-05	CHIP R 0 OHM	
R347			R92-1252-05	CHIP R 0 OHM J 1/16W		R407			RK73HB1J124J	CHIP R 120K J 1/16W	
R348			RK73HB1J102J	CHIP R 1.0K J 1/16W		R408			RK73GB1J223J	CHIP R 22K J 1/16W	
R349			RK73HB1J331J	CHIP R 330 J 1/16W		R409			RK73HB1J563J	CHIP R 56K J 1/16W	
R350			R92-0670-05	CHIP R 0 OHM		R410			RK73HB1J105J	CHIP R 1.0M J 1/16W	

PARTS LIST / 零件表

TX-RX UNIT (X57-6243-XX)

Ref. No.	Address	New parts	Parts No.	Description	Destination	Ref. No.	Address	New parts	Parts No.	Description	Destination
R411			RK73HB1J103J	CHIP R 10K J 1/16W		VR302			R32-0647-05	SEMI FIXED VARIABLE RESISTOR	
R412			RK73HB1J473J	CHIP R 47K J 1/16W		VR303			R12-7487-05	TRIMMING POT.(15K)	
R413			RK73HB1J562J	CHIP R 5.6K J 1/16W							
R414			RK73HB1J183J	CHIP R 18K J 1/16W		S100			S40-1117-05	TACT SWITCH	
R415			RK73GB1J474J	CHIP R 470K J 1/16W		S300			S60-0419-05	ROTARY SWITCH	
R416			RK73HB1J222J	CHIP R 2.2K J 1/16W		D1			MA742	DIODE	
R417			RK73GB1J183J	CHIP R 18K J 1/16W		D2			MA2S111	DIODE	
R418			RK73HB1J102J	CHIP R 1.0K J 1/16W		D3			1SR154-400	DIODE	
R419			RK73HB1J272J	CHIP R 2.7K J 1/16W		D6,7			MA2S376	VARIABLE CAPACITANCE DIODE	
R420			RK73HB1J823J	CHIP R 82K J 1/16W		D9			MA2S376	VARIABLE CAPACITANCE DIODE	
R421			R92-0670-05	CHIP R 0 OHM		D11			MA2S376	VARIABLE CAPACITANCE DIODE	
R422,423			RK73HB1J103J	CHIP R 10K J 1/16W		D12			MA360	VARIABLE CAPACITANCE DIODE	
R424			RK73HB1J563J	CHIP R 56K J 1/16W		D13			MA2S111	DIODE	
R425			RK73HB1J153J	CHIP R 15K J 1/16W		D14,15			HSC277	DIODE	
R426			RK73HB1J184J	CHIP R 180K J 1/16W		D16-18			HVC350B	VARIABLE CAPACITANCE DIODE	
R427			RK73HB1J104J	CHIP R 100K J 1/16W		D19			HZU5ALL	DIODE	
R430			RK73HB1J182J	CHIP R 1.8K J 1/16W		D21,22			HVC350B	VARIABLE CAPACITANCE DIODE	
R431			RK73HB1J332J	CHIP R 3.3K J 1/16W		D23			HVC355B	VARIABLE CAPACITANCE DIODE	
R432			RK73GB1J682J	CHIP R 6.8K J 1/16W		D24			HVC131	DIODE	
R433			RK73HB1J102J	CHIP R 1.0K J 1/16W		D25,26			HSC277	DIODE	
R434			RK73GB1J333J	CHIP R 33K J 1/16W		D27			HVC131	DIODE	
R436			RK73HB1J222J	CHIP R 2.2K J 1/16W		D28			MA2S111	DIODE	
R437			RK73HB1J124J	CHIP R 120K J 1/16W		D301			MA742	DIODE	
R438			RK73HB1J473J	CHIP R 47K J 1/16W		D302			KD24.7EV	ZENER DIODE	
R439			RK73HB1J104J	CHIP R 100K J 1/16W		D306			DA221	DIODE	
R440			R92-1368-05	CHIP R 0 OHM		D307			1SS372	DIODE	
R441			RK73HB1J563J	CHIP R 56K J 1/16W		D308			DAN222	DIODE	
R442			RK73HB1J154J	CHIP R 150K J 1/16W		D309			KDZ3.0V	ZENER DIODE	
R443			RK73HB1J823J	CHIP R 82K J 1/16W		IC1			MB15E03SL	MOS IC	
R444			RK73HB1J105J	CHIP R 1.0M J 1/16W		IC2			TA31136FN	MOS IC	
R445			RK73HB1J103J	CHIP R 10K J 1/16W		IC3			NJM2904V	MOS IC	
R446			RK73HB1J102J	CHIP R 1.0K J 1/16W		IC300			M38267M8L271G	P MPU	
R447			RK73GB1J683J	CHIP R 68K J 1/16W		IC301			LC73881M	MOS IC	
R448			RK73HB1J473J	CHIP R 47K J 1/16W		IC302			AT24C16N-10SI	ROM IC	
R449			RK73HB1J222J	CHIP R 2.2K J 1/16W		IC302			24LC16BT-I/SN	ROM IC	
R450			RK73HB1J101J	CHIP R 100 J 1/16W		IC303			PST9145NR	MOS IC	
R451			RK73HB1J392J	CHIP R 3.9K J 1/16W		IC304			PST9124NR	MOS IC	
R452			R92-0670-05	CHIP R 0 OHM		IC305			XC62FP3502P	MOS IC	
R453			RK73GB1J101J	CHIP R 100 J 1/16W		IC306			NJM2902V	MOS IC	
R454			RK73HB1J821J	CHIP R 820 J 1/16W		IC307			NJM2904V	MOS IC	
R455			RK73GB1J474J	CHIP R 470K J 1/16W		IC308			NJM2902V	MOS IC	
R456			RK73GB1J182J	CHIP R 1.8K J 1/16W	C4	IC309			KIA6278F	BI-POLAR IC	
R456			RK73GB1J392J	CHIP R 3.9K J 1/16W	C	Q1			2SC4738(GR)	TRANSISTOR	
R457			RK73GB1J100J	CHIP R 10 J 1/16W		Q2			KTC4082	TRANSISTOR	
R458			RK73HB1J182J	CHIP R 1.8K J 1/16W		Q3			2SC5108(Y)	TRANSISTOR	
R459			RK73HB1J471J	CHIP R 470 J 1/16W		Q4,5			2SC5066(O)	TRANSISTOR	
R460			RK73HB1J563J	CHIP R 56K J 1/16W		Q6			KTC4082	TRANSISTOR	
R462			RK73HB1J333J	CHIP R 33K J 1/16W		Q7			2SC5108(Y)	TRANSISTOR	
R464			RK73HB1J101J	CHIP R 100 J 1/16W		Q8			2SJ243	FET	
R466			R92-1252-05	CHIP R 0 OHM J 1/16W		Q9			KRX102U	TRANSISTOR	
R467,468			RK73HB1J473J	CHIP R 47K J 1/16W		Q10			2SC4617(S)	TRANSISTOR	
R469			R92-1252-05	CHIP R 0 OHM J 1/16W		Q11			2SC5108(Y)	TRANSISTOR	
R470,471			RK73HB1J473J	CHIP R 47K J 1/16W		Q12			3SK320	FET	
R477			RK73HB1J103J	CHIP R 10K J 1/16W		Q13			2SC5108(Y)	TRANSISTOR	
VR1			R12-7491-05	TRIMMING POT.(68K)		Q14			DTC114TE	DIGITAL TRANSISTOR	
VR301			R12-7491-05	TRIMMING POT.(68K)		Q15			2SC4988	TRANSISTOR	

PARTS LIST / 零件表

TX-RX UNIT (X57-6243-XX)

Ref. No.	Address	New parts	Parts No.	Description	Destination	Ref. No.	Address	New parts	Parts No.	Description	Destination
Q17			2SK1824	FET							
Q18			2SK3475	FET							
Q20			3SK274	FET							
Q22			2SK3476	FET							
Q23			DTA144EE	DIGITAL TRANSISTOR							
Q24			DTC144EUA	DIGITAL TRANSISTOR							
Q300-302			DTC114EE	DIGITAL TRANSISTOR							
Q303			DTC114YE	DIGITAL TRANSISTOR							
Q304			DTA123JE	DIGITAL TRANSISTOR							
Q305			UMG3N	TRANSISTOR							
Q306			UPA672T	FET							
Q307			FP210	TRANSISTOR							
Q308			UMG3N	TRANSISTOR							
Q309			DTA123JE	DIGITAL TRANSISTOR							
Q310			KTA1298(Y)	TRANSISTOR							
Q311			UMG3N	TRANSISTOR							
Q312			DTC144EE	DIGITAL TRANSISTOR							
Q313			2SK1824	FET							
Q314			2SC4617(S)	TRANSISTOR							
Q315			DTC114EE	DIGITAL TRANSISTOR							
Q316			DTA144EE	DIGITAL TRANSISTOR							
Q317			2SC4738(GR)	TRANSISTOR							
Q318			2SK1824	FET							
Q319			DTA144EE	DIGITAL TRANSISTOR							
Q320			DTC144EE	DIGITAL TRANSISTOR							
Q321			KTA1298(Y)	TRANSISTOR							
Q322			2SC4919	TRANSISTOR							
Q323			DTC144EE	DIGITAL TRANSISTOR							
Q324			2SK1588	FET							
Q325			DTA123JE	DIGITAL TRANSISTOR							
TH1			157-503-65001	THERMISTOR							
TH301			157-303-65001	THERMISTOR							
TH302			157-102-65001	THERMISTOR							
S301			W02-3614-05	ENCODER							

EXPLODED VIEW / 部件分解图

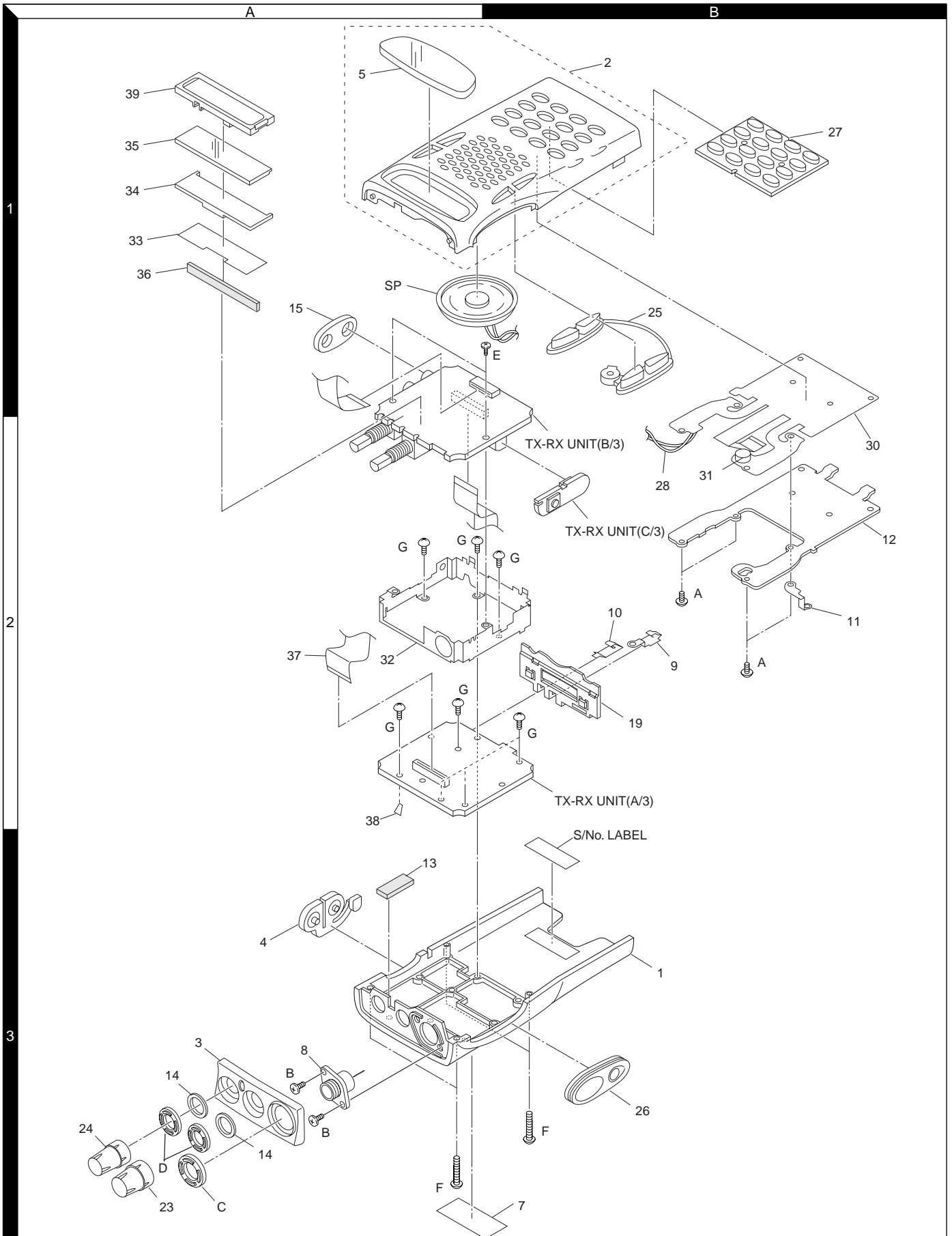

Parts with exploded numbers larger than 700 are not supplied.

PACKING / 包装

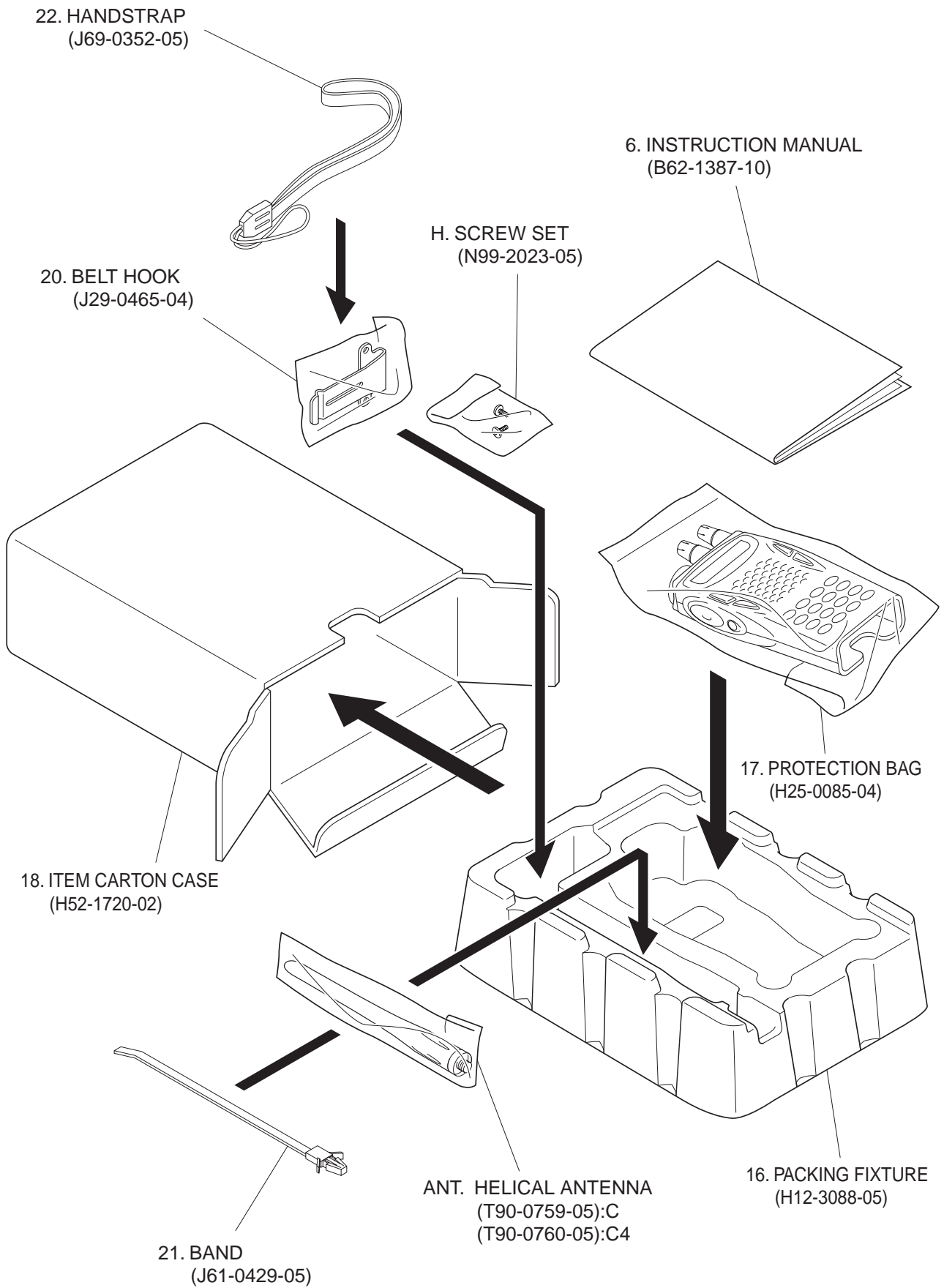

ADJUSTMENT / 调整

Required Test Equipment

1. Stabilized Power supply

1. The supply voltage can be changed between 5V and 9V, and the current is 3A or more.
2. The standard voltage is 7.5V.

2. DC Ammeter

1. Class 1 ammeter (17 ranges and other features).
2. The full scale can be set to either 300mA or 3A.
3. A cable of less internal loss must be used.

3. Frequency Counter (f. counter)

1. Frequencies of up to 1GHz or so can be measured.
2. The sensitivity can be changed to 500MHz or below, and measurements are highly stable and accurate (0.2ppm or so).

4. Power Meter

1. Measurable frequency : Up to 500MHz
2. Impedance : 50Ω, unbalanced
3. Measuring range : Full scale of 10W or so
4. A standard cable (5D2W 1m) must be used.

5. RF Voltmeter(RF V.M)

1. Measurable frequency : Up to 500MHz or so.

6. Linear Detector

1. Measurable frequency : Up to 500MHz or so
2. Characteristics are flat, and CN is 60dB or more.

7. Digital Voltmeter

1. Voltage range : FS=18V or so
2. Input resistance : 1MΩ or more

8. Oscilloscope

1. Measuring range : DC to 30MHz
2. Provides highly accurate measurements for 5 to 25MHz.

9. AF Voltmeter (AF V.M)

1. Measurable frequency : 50Hz to 1MHz
2. Maximum sensitivity : 1mV or more

10. Spectrum Analyzer

1. Measuring range : DC to 1GHz or more

11. Standard Signal Generator (SSG)

1. Maximum frequency : 500MHz or more
2. Output : -133dBm/0.05μV to 7dBm/501mV
3. Output impedance : 50Ω

12. Tracking Generator

1. Center frequency : 50kHz to 500MHz
2. Frequency deviation : ±35MHz
3. Output voltage : 100mV or more

13. Dummy Load

1. 8Ω, 3W or more

14. AF Generator(AG)

1. Frequency range : 100Hz to 100kHz
2. Output : 0.5mV to 1V

15. Distortion Meter

1. Measurable frequency : 30Hz to 100kHz
2. Input level : 50mV to 10Vrms

所需的测试设备

1. 稳定电源

1. 输出电源在5V和9V之间可调，并且电流为3A或更大。
2. 标准电压为7.5V。

2. 电流表

1. 高级电流表 (17档和其他功能)。
2. 满刻度可设定为300mA也可设定为3A。
3. 必须使用低损耗电缆。

3. 频率计数器 (f.counter)

1. 可以测量到最大量程大约为1GHz的频率。
2. 灵敏度可调到500MHz或更低，测量为高稳定性和高准确度 (大约为0.2ppm)。

4. 功率仪

1. 可测量的频率：最高到500MHz
2. 阻抗：50Ω，不稳定
3. 测量范围：满刻度大约为10W。
4. 必须使用标准电缆 (5D2W 1m)。

5. 射频电压表 (RF V.M)

1. 频率范围：最高大约到500MHz。

6. 线性检测器

1. 频率范围：最高大约到500MHz。
2. 特征函数是平展的，CN为60dB或更大。

7. 数字电压表

1. 电压范围：大约FS = 18V。
2. 输入阻抗值：1MΩ或更大。

8. 示波器

1. 测量范围：直流到30MHz
2. 5到25MHz间提供高准确度测量。

9. 音频电压表 (AF V.M)

1. 频率范围：50Hz到1MHz
2. 最高灵敏度：1mV或更高

10. 频谱分析仪

1. 测量范围：直流到1GHz或更大

11. 标准信号发射器 (SSG)

1. 最高频率：500MHz或更高
2. 输出：-133dBm/0.05μV到7dBm/501mV
3. 输出阻抗：50Ω

12. 轨迹发生器

1. 中心频率：50kHz到500MHz
2. 频偏：±35MHz
3. 输出电压：100mV或更高

13. 假负载

1. 8Ω, 3W或更高

14. 音频发生器 (AG)

1. 频率范围：100Hz到100kHz
2. 输出：0.5mV到1V

15. 失真测试仪

1. 频率范围：30Hz到100kHz
2. 输入电平：50mV到10Vrms

ADJUSTMENT / 调整

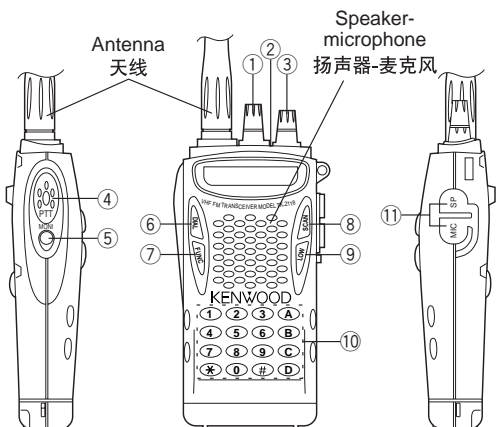

- | | |
|-------------------------|--------------|
| ① Power / Volume switch | ⑦ FUNC key |
| ② LED indicator | ⑧ SCAN key |
| ③ Channel switch | ⑨ LOW key |
| ④ PTT switch | ⑩ DTMF key |
| ⑤ MONI key | ⑪ SP/MIC JAC |
| ⑥ DIAL key | |
-
- | | |
|-----------------|------------------|
| ① 电源 / 音量控制器 | ⑦ FUNC (功能) 键 |
| ② LED指示灯 | ⑧ SCAN (扫描) 键 |
| ③ 旋转编码器 | ⑨ LOW 键 |
| ④ PTT (按下通话) 开关 | ⑩ DTMF (双音多频) 键盘 |
| ⑤ MONI (监听器) 键 | ⑪ MIC-SP插孔 |
| ⑥ DIAL (拨号) 键 | |

- Use a non-conductive rod such as a Ceramic rod for adjustment (especially of trimmers and coils).
Kenwood order No. A-0910 (0.4X0.9mm)
Kenwood order No. A-1310 (0.4X1.3mm)
- To protect the SSG, do not send out signals while adjusting the receiving unit.
- The indicated SSG output levels are for maximum output.

- 使用一个专用调整棒进行调整（特别是微调电容器和线圈）。
建伍订货单号码 A-0910 (0.4X0.9mm)
建伍订货单号码 A-1310 (0.4X1.3mm)
- 为了保护标准信号发生器，在调整接收部分时通信机不要发射。
- 显示的标准信号发生器输出电平为最大输出值。

Adjustment point

TX-RX A/3 Component side

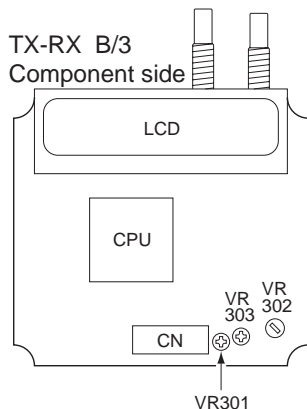
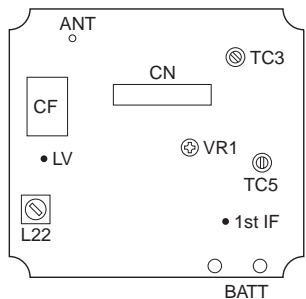

TX-RX A/3 Foil side

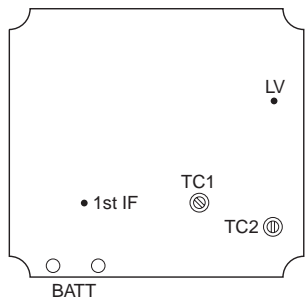

Component Side View

- VR1: Frequency adjustment
- TC3: Band-pass filter waveform adjustment
- TC5: Band-pass filter waveform adjustment
- L22: AF level adjustment
- LV: Lock voltage adjustment terminal
- 1st IF: Band-pass filter test point
- VR301: DQT waveform adjustment
- VR302: Deviation adjustment
- VR303: DTMF deviation adjustment

- VR1: 频率调整
- TC3: 带通滤波器波形调整
- TC5: 带通滤波器波形调整
- L22: 音频电平调整
- LV: 锁定电压调整终端
- 1st: 带通滤波器测试点
- VR301: DQT波形调整
- VR302: DEV调整
- VR303: DTMF DEV调整

Foil Side View

- TC1: Transmit lock voltage adjustment
- TC2: Receive lock voltage adjustment
- TC1: 发射锁定电压调整
- TC2: 接收锁定电压调整

Notes:

- Adjust the TX VCO trimmer within a short period of time (Appros. 10 seconds). When the transceiver is in TX mode and the final amplifier transistor is detached from the chassis for a long time, it may cause thermal damage to the transistor (No heatsink).

注释:

- 在短时间内调整发射压控微调电容器（大约10秒）。当收发机处于发射模式，并且末级放大器晶体管长时间从机架拔出时，则可能会对晶体管产生热损伤（无散热器）。

ADJUSTMENT / 调整

Replacing Q22 (FET TX final)

- Place Q22 in its location, upside down as shown in figure 1. Make sure the location of each pin is correct. The bevelled edge is located between pin 1 and 2. (See the figure below) Replace the heat conductor sheet (G11-2664-x4) when replacing Q22.

重置Q22 (FET 发射终端)

- 如图1所示，将Q22上下颠倒放在它的对应位置。每个管脚的位置一定要正确。斜角位于管脚1与管脚2之间。（如下图所示）当置换Q22时，重置热导膜（G11-2664-x4）。

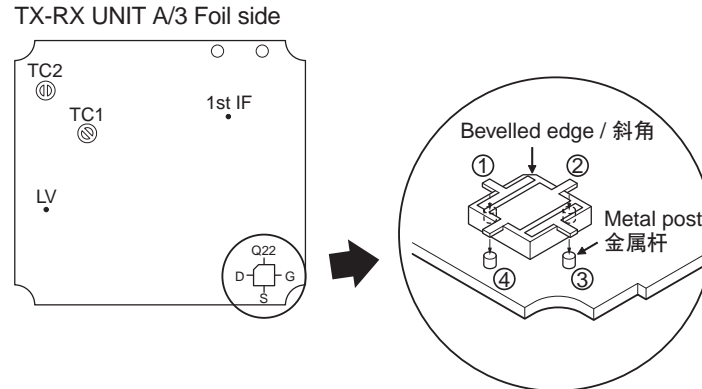

Fig. 1 / 图1

- The bottom surface of Q22 must be firmly contacted to the TX-RX PCB. Solder each pin onto the top of the metal posts. Make sure the solder is between the pin and the metal post (Refer to figure 2).
- Q22的底部表面必须与发射-接收PCB紧密结合。将每个管脚与金属杆的顶端焊接起来。焊剂必须位于管脚与金属杆之间。（参见图2）

Note:

- Make sure you are properly grounded while soldering the Q22.
- Avoid adding excess solder to the metal post.
- Make sure the bottom surface of Q22 is firmly contacted to the TX-RX PCB.
- The metal posts for the pins are also soldered to the PCB. So, when you solder the Q22 pins to the metal posts, keep the soldering time as short as possible so that the posts are not moved.

注释:

- 当焊接Q22时一定要将焊剂研磨恰当。
- 避免向金属杆添加过多焊剂。
- Q22的底部表面一定要与发射-接收PCB紧密结合。
- 管脚所对应的金属杆也要与PCB焊接在一起。所以，将Q22管脚与金属杆焊接起来时，尽可能使焊接时间越短越好，这样金属杆不易被移动。

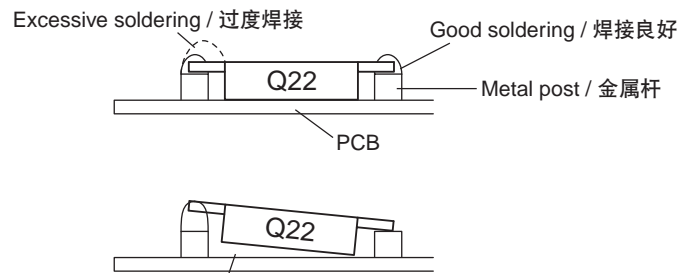

Wrong! The bottom surface must be firmly contacted to the PCB.
错误！底部表面必须与PCB紧密结合。

Fig. 2 / 图2

ADJUSTMENT

Use the KPG-69D programming software for adjustment of the next item in PC MODE (see page 10).

Squelch Level, S meter Level, Lo Power, Hi Power, QT Deviation, DQT Deviation, and Battery warning.

Section common to the transmitter and receiver (VCO)

Item	Condition	Measurement		Adjustment		Specifications/Remarks	
		Test equipment	Terminal	Parts	Method		
1. Setting	1) Power supply voltage Battery terminal: 7.5V						
2. VCO lock voltage	1) CH: TX low	Digital voltmeter	CV	TC1	1.0V (C,C4)	±0.1V	
	2) CH: RX low			TC2	1.0V (C,C4)	±0.1V	
	3) CH: TX high						
	4) CH: RX high						less than 4.5V

Receiver Section

Item	Condition	Measurement		Adjustment		Specifications/Remarks		
		Test equipment	Terminal	Parts	Method			
1. Band-pass filter	1) CH: RX center	Tra generator Spectrum analyzer		TC3,TC5	Adjust the spectram waveform shown Fig1			
2. AF level	1) CH: RX center SSG output: -53dBm(501µV) MOD: 1kHz DEV: ±3.0kHz	SSG Oscilloscope AF: V. M Distortion meter	ANT SP	L22	Adjust to the MAX AF level Vol. knob position at 12 o'clock			
3. Sensitivity	1) CH: RX center CH: low CH: high SSG ouput: -116dBm(0.35µV) MOD: 1kHz DEV: ±3.0kHz						Check	SINAD: 12dB or higher
4. Squelch Level (PC Mode)	1) CH: RX center						PC key	Adjust to open the squelch.
	2) Level 9 SSG output: -116dBm(0.35µV)							
	3) Level 1 SSG output: -123dBm(0.16µV)	Adjust to open the squelch.						
5. S meter Level (PC Mode)	1) CH: RX center	SSG	ANT	PC key	Adjust to Full digit			
	2) Full digit SSG output: -110dBm(0.7µV)						Adjust to one digit	
	3) one Digit SSG output: -120dBm(0.2µV)							

Transmitter section

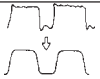
Item	Condition	Measurement		Adjustment		Specifications/Remark
		Test equipment	Terminal	Parts	Method	
1. Transmit frequency	1) CH: TX center PTT: ON	Frequency counter	ANT	VR1	Adjust to center frequency	within ±100Hz
2. DQT/QT Balance	1) CH: TX center	Modulation analyzer		VR301	Rectify the waveform to square wave	
3. Lo Power (PC Mode)	1) CH: TX center CH: TX low CH: TX high	Power meter Current meter		PC key	Adjust it to 2W	within ±0.1W
4. Hi Power (PC Mode)	1) CH: TX center CH: TX low CH: TX high	Power meter Current meter		PC key	Adjust it to 5W	within ±0.2W
5. MAX DEV	1) CH: TX center AG: 1kHz/50mV	Modulation analyzer 15kHz LPF AG, AF. V. M		VR302	Adjust it to ± 4.2kHz (Wide)	±100Hz
					Check (Narrow)	±1.9kHz~2.2kHz
6. MIC Sensitivity	1) CH: TX center AG: 1kHz/5mV				Check (Wide)	±2.2kHz~3.8kHz
				PC key	Adjust it to 0.75kHz (Wide) Adjust it to ±0.35kHz (Narrow) CH: TX Center	±0.05Hz (Wide/Narrow)
8. DQT Deviation (PC Mode)	1) CH: TX center CH: TX low CH: TX high QT: 151.4Hz	Modulation analyzer 3kHz LPF		PC key	Adjust it to ± 0.75kHz (Wide) Adjust it to ±0.35kHz (Narrow) CH: TX Center	±0.05Hz (Wide/Narrow)
				PC key	Adjust it to ± 0.75kHz (Wide) Adjust it to ±0.35kHz (Narrow) CH: TX Center	±0.05Hz (Wide/Narrow)
9. DTMF Deviation	1) CH TX center using [9] key analyzer 15kHz LPF	Modulation		VR303	Adjust it to 2.5kHz (Wide)	±100Hz
10. VOX Level (PC Mode)				PC key	Adjust it to [4]	
11. Battery Warning (PC Mode)	1) Battery terminal: 5.5V			PC key		

调整

在计算机模式下使用KPG-69D编程软件调整下记项目(参见第10页)

噪音抑制电路电平、S计电平、低功率、高功率、QT偏差、DQT偏差、电池警告

发射部和接收部公用部分(压控振荡器)

项目	条件	测量		调整		规格/备注
		测试设备	终端	部件	方法	
1. 设定	1) 电源电压电池终端: 7.5V					
2. 压控振荡器	1) CH: 发射低端频点	数字电压表	CV	TC1	1.0V	±0.1V
	2) CH: 接收低端频点				1.0V	±0.1V
	3) CH: 发射高端频点					低于 4.5V
	4) CH: 接收高端频点					

接收部

项目	条件	测量		调整		规格/备注
		测试设备	终端	部件	方法	
1. 带电滤波器	1) CH: 接收中心频点	Tra 发生器 频谱分析仪		TC3,TC5	调整频谱波形	
2. 音频电平	1) CH: 接收中心频点 SSG 输出: -53dBm (501μV) MOD: 1kHz DEV: ±3.0kHz	标准信号发射器 示波器 音频电压表 失真测试仪	天线 扬声器	L22	调整到最大音频电平 音量旋钮位置位于12点	
3. 灵敏度	1) CH: 接收中心频点 CH: low CH: high SSG 输出: -116dBm (0.35μV) MOD: 1kHz DEV: ±3.0kHz				检查	SINAD: 12dB或更高
4. 噪音抑制电路电平(计算机模式)	1) CH: 接收中心频点			PC机键	经调整打开静音	
	2) 第9级 SSG 输出: -116dBm (0.35μV)				经调整打开静音	
	3) 第11级 SSG 输出: -123dBm (0.16μV)					
5. S计电平(计算机模式)	1) CH: 接收中心频点	SSG	天线	PC机键	调节成全数字	
	2) Full digit SSG 输出: -110dBm (0.7μV)				调节成单数字	
	3) one Digit SSG 输出: -120dBm (0.2μV)					

发射部

项目	条件	测量		调整		规格/备注	
		测试设备	终端	部件	方法		
1. 发射频率	1) CH: 发射中心频点 PTT: 开启	频率计数器	天线	VR1	调整频率	±100Hz以内	
2. DQT/QT平衡	1) CH: 发射中心频点	频谱分析仪		VR301	将波形整流为方形波		
3. 低功率(计算机模式)	1) CH: 发射中心频点 CH: 发射低频点 CH: 发射高频点	功率表 电流表		PC机键	调整到 2W	±0.1W以内	
4. 高功率(计算机模式)	1) CH: 发射中心频点 CH: 发射低频点 CH: 发射高频点	功率表 电流表		PC机键	调整到 5W	±0.2W以内	
5. 最大DEV	1) CH: 发射中心频点 AG: 1kHz/50mV	频谱分析仪 15kHz LPF AG, AF, V, M		VR302	调整到 4.2kHz (宽)	±100Hz	
6. 调制灵敏度	1) CH: 发射中心频点 AG: 1kHz/5mV					检查(窄)	±1.9kHz~2.2kHz
						检查(宽)	±2.2kHz~3.8kHz
7. QT DEV(计算机模式)	1) CH: 发射中心频点 CH: 发射低频点 CH: 发射高频点 QT: 151.4Hz	频谱分析仪 3kHz LPF		PC机键	调整到 0.75kHz (宽) 调整到 ±0.35kHz (窄) CH: 发射中心频点	±0.05Hz (宽/窄)	
8. DQT DEV(计算机模式)	1) CH: 发射中心频点 CH: 发射低频点 CH: 发射高频点 DQT:023N	频谱分析仪 3kHz LPF		PC机键	调整到 ±0.75kHz (宽) 调整到 ±0.35kHz (窄) CH: 发射中心频点	±0.05Hz (宽/窄)	
9. DTMF DEV	1) CH TX 中心, 使用 [9] 键	频谱分析仪 15kHz LPF		VR303	调整到 2.5kHz (宽)	±100Hz	
10. VOX 电平(计算机模式)				PC机键	调整到 [4]		
11. 电池警告(计算机模式)	1) 电池终端: 5.5V			PC机键			

ADJUSTMENT / 调整

ADJUSTMENT FREQUENCY LIST

Destination	C		C4	
	TX f (MHz)	RX f (MHz)	TX f (MHz)	RX f (MHz)
Center	460.00	460.05	410.00	410.05
Low	450.00	450.05	400.00	400.05
Hi	470.00	469.95	420.00	419.95

调整频率清单

型式	C		C4	
	发射频率 (MHz)	接收频率 (MHz)	发射频率 (MHz)	接收频率 (MHz)
信道中心	460.00	460.05	410.00	410.05
低	450.00	450.05	400.00	400.05
高	470.00	469.95	420.00	419.95

BPF-Wave

• TK-3118 (C type)

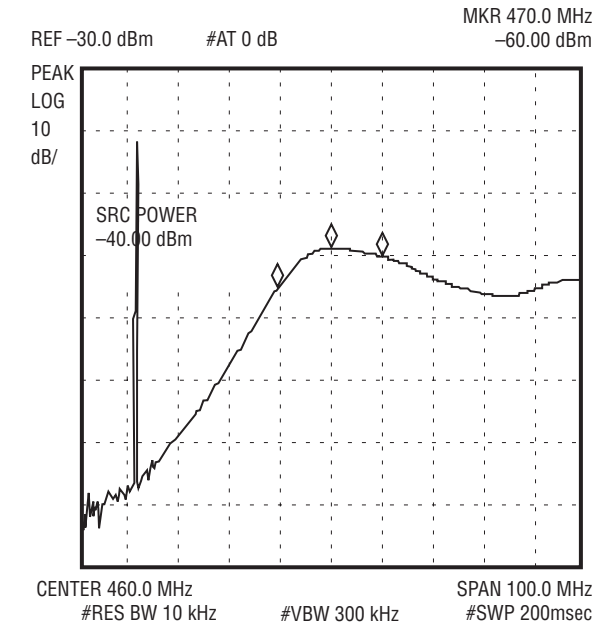

• TK-3118 (C4 type)

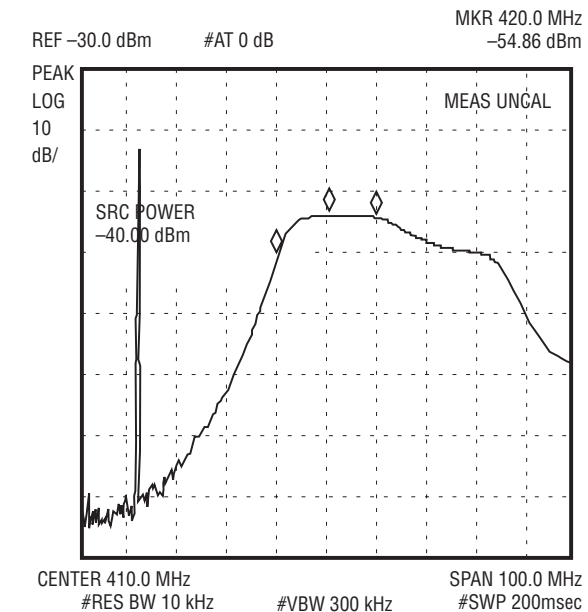

Fig. 1 / 图1

Notes:

- Adjust the TX VCO trimmer within a short period of time (Appros. 10 seconds). When the transceiver is in TX mode and the final amplifier transistor is detached from the chassis for a long time, it may cause thermal damage to the transistor (No heatsink).

注释:

- 在短时间内调整发射压控微调电容器(大约10秒)。当收发机处于发射模式,并且末级放大器晶体管长时间从机架拔出时,则可能会对晶体管产生热损伤(无散热器)。

TK-3118

PC BOARD VIEW / PC 板视图

DISPLAY UNIT (X41-3583-00) Component side view

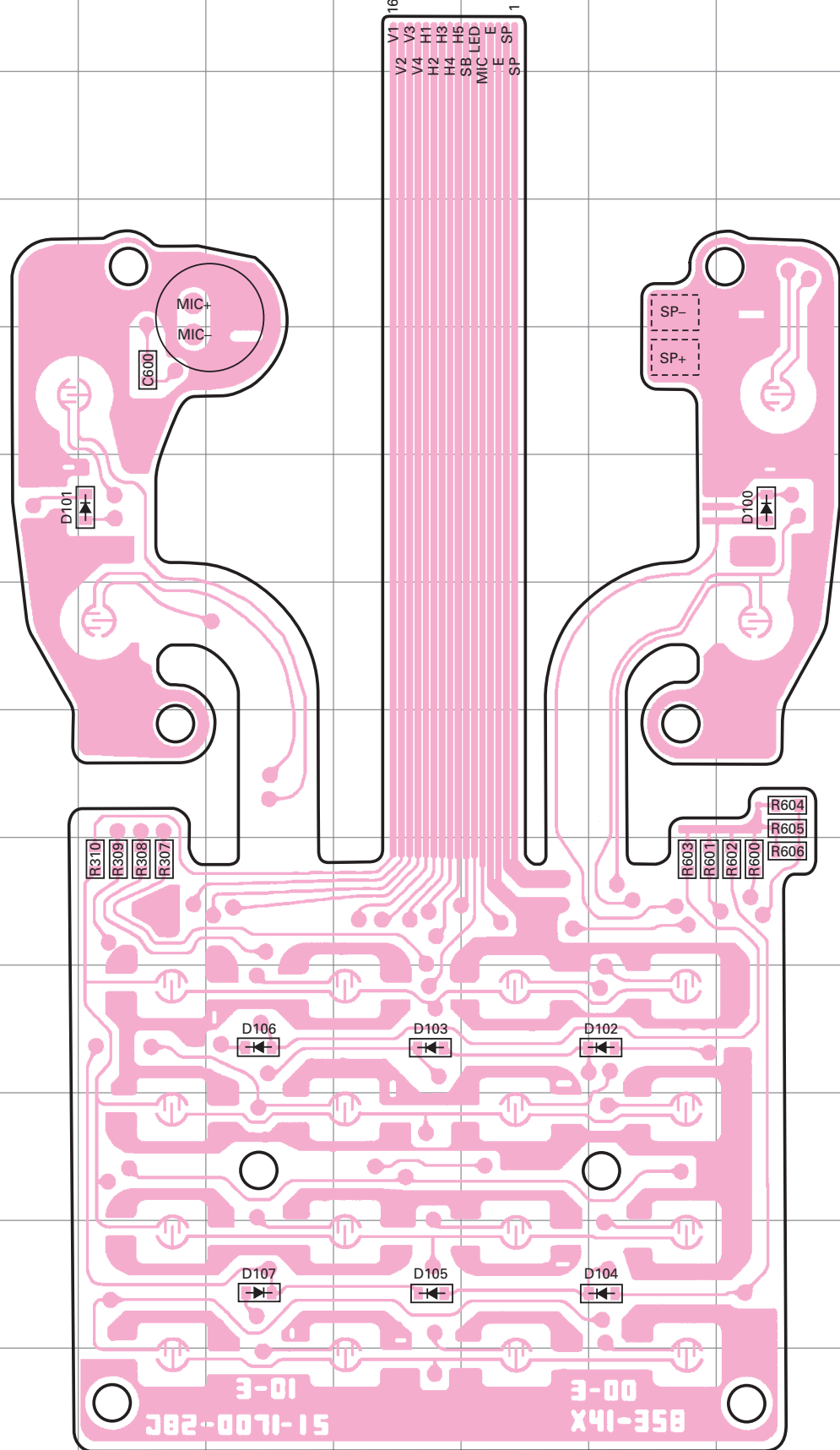

DISPLAY UNIT (X41-3583-00) Foil side view

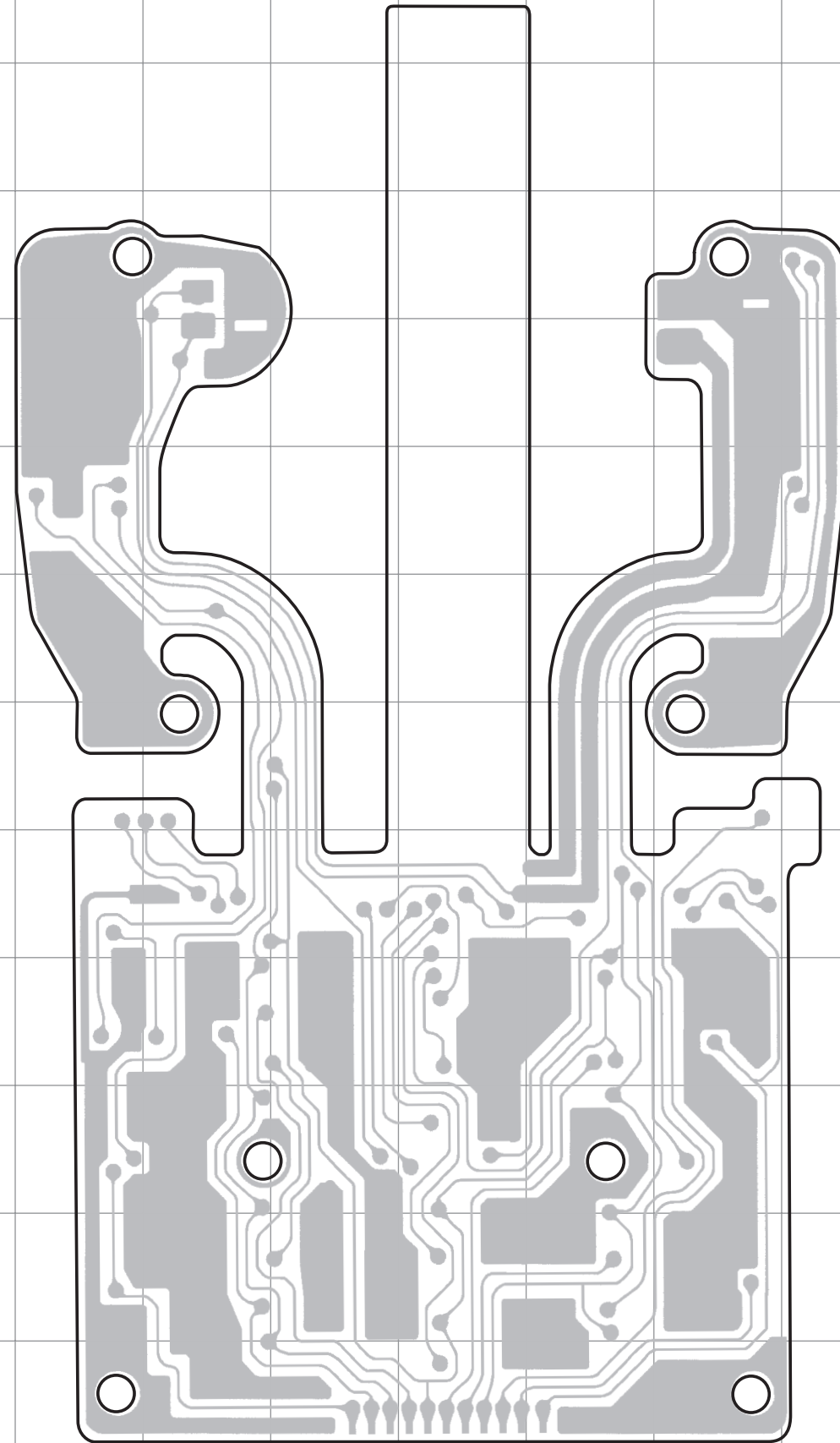

DISPLAY UNIT (X41-3583-00)
Component side view

Ref. No.	Address
D100	6H
D101	6C
D102	10G
D103	10E
D104	12G
D105	12E
D106	10D
D107	12D

Component side
 Foil side

PC BOARD VIEW / PC 板视图 TK-3118

TX-RX UNIT (X57-6243-XX) -00:C -01:C4 Component side view

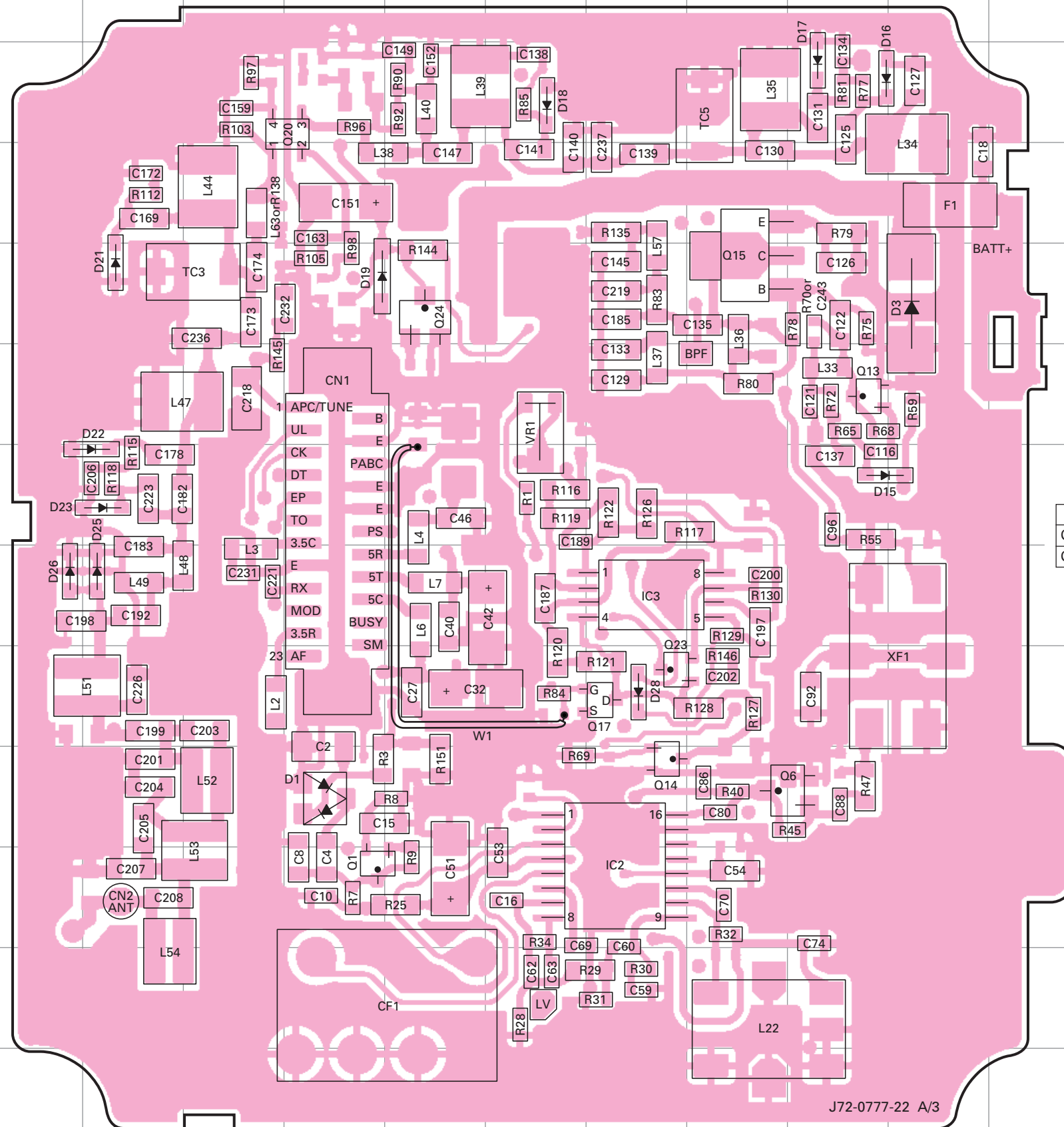

TX-RX UNIT (X57-6243-XX) (A/3)
Component side view

Ref. No.	Address
IC2	11H
IC3	8H
Q1	10E
Q6	10J
Q13	6J
Q14	10H
Q15	5I
Q17	9H
Q20	3E
Q21	5G
Q23	9H
Q24	5F
D1	10E
D3	5K
D15	7J
D16	3K
D17	3J
D18	3G
D19	5E
D21	5C
D22	7C
D23	7C
D25	8C
D26	8B
D28	9H

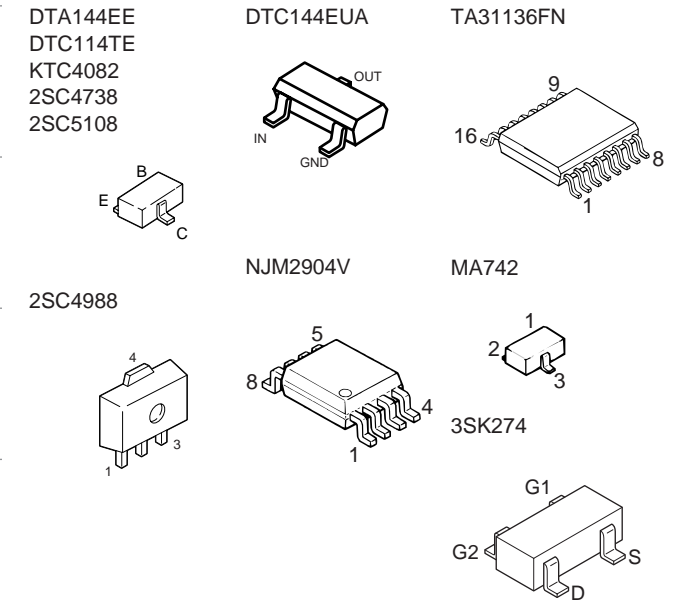

	R70	R84	R138	C243	L63	W1
C	YES	YES	NO	NO	YES	NO
C4	NO	NO	YES	YES	NO	YES

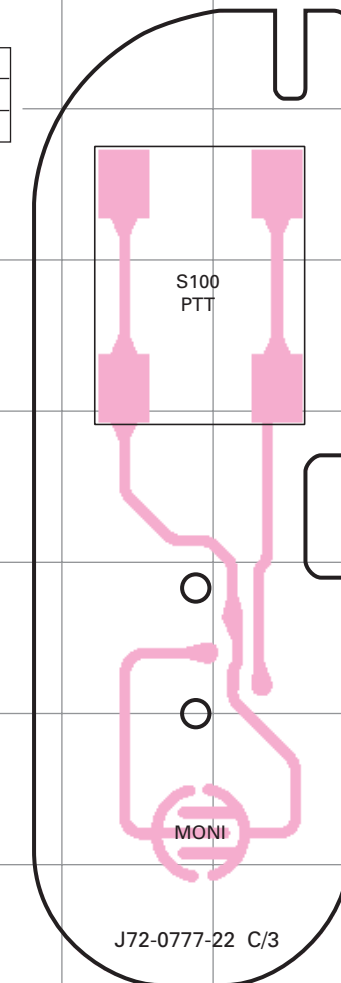
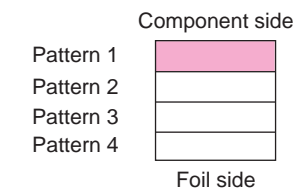

J72-0777-22 A/3

J72-0777-22 C/3

TK-3118 PC BOARD VIEW / PC 板视图

TX-RX UNIT (X57-6243-XX) -00:C -01:C4 Foil side view

KTC4082
2SC4617
2SC5066
2SC5108



3SK320

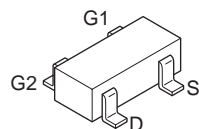

2SJ243

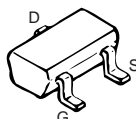

KRX102U

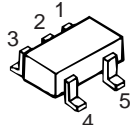

MB15E03SL

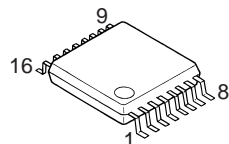

2SK3476

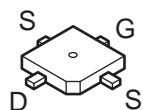

2SK3475

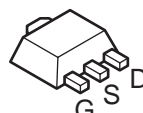

TX-RX UNIT (X57-6243-XX) (A/3)
Foil side view

Ref. No.	Address
IC1	80
Q2	10N
Q3	7L
Q4	11J
Q5	10J
Q7	9I
Q8	8J
Q9	8K
Q10	7J
Q11	8I
Q12	5K
Q18	3M
Q22	4Q
D2	7N
D6	10K
D7	13K
D9	10L
D11	12K
D12	8J
D13	7J
D14	6J
D24	9Q
D27	9Q

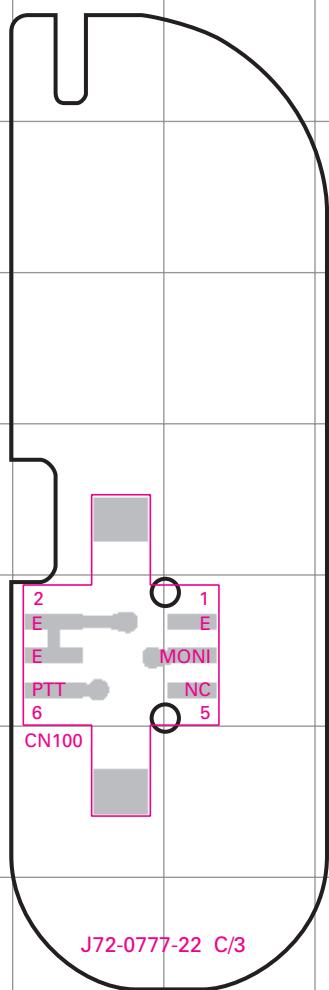

J72-0777-22 C/3

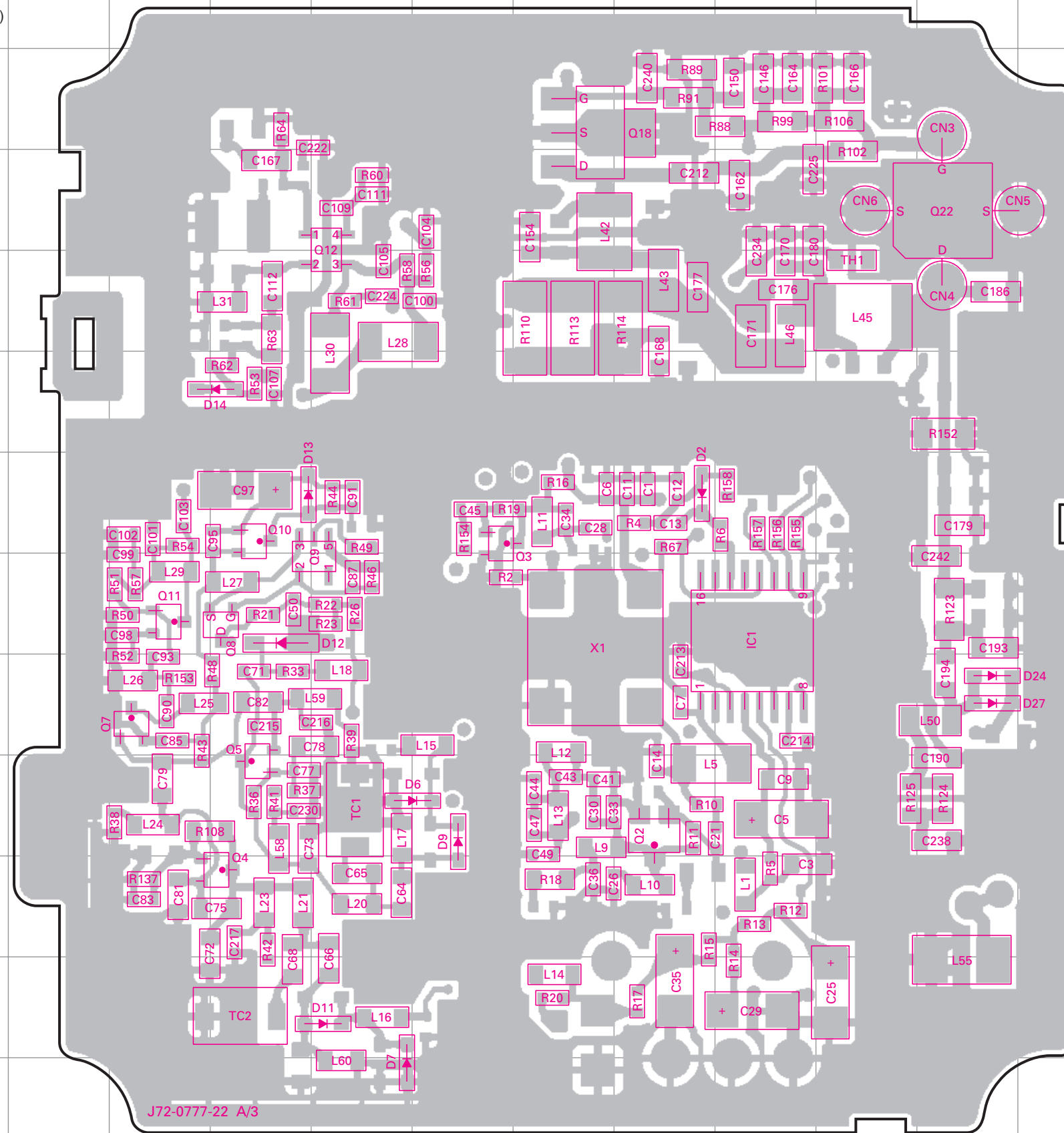
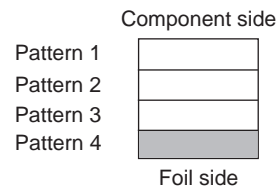

J72-0777-22 A/3

PC BOARD VIEW / PC板视图 TK-3118

TX-RX UNIT (X57-6243-XX) -00:C -01:C4 Component side view + Foil side view

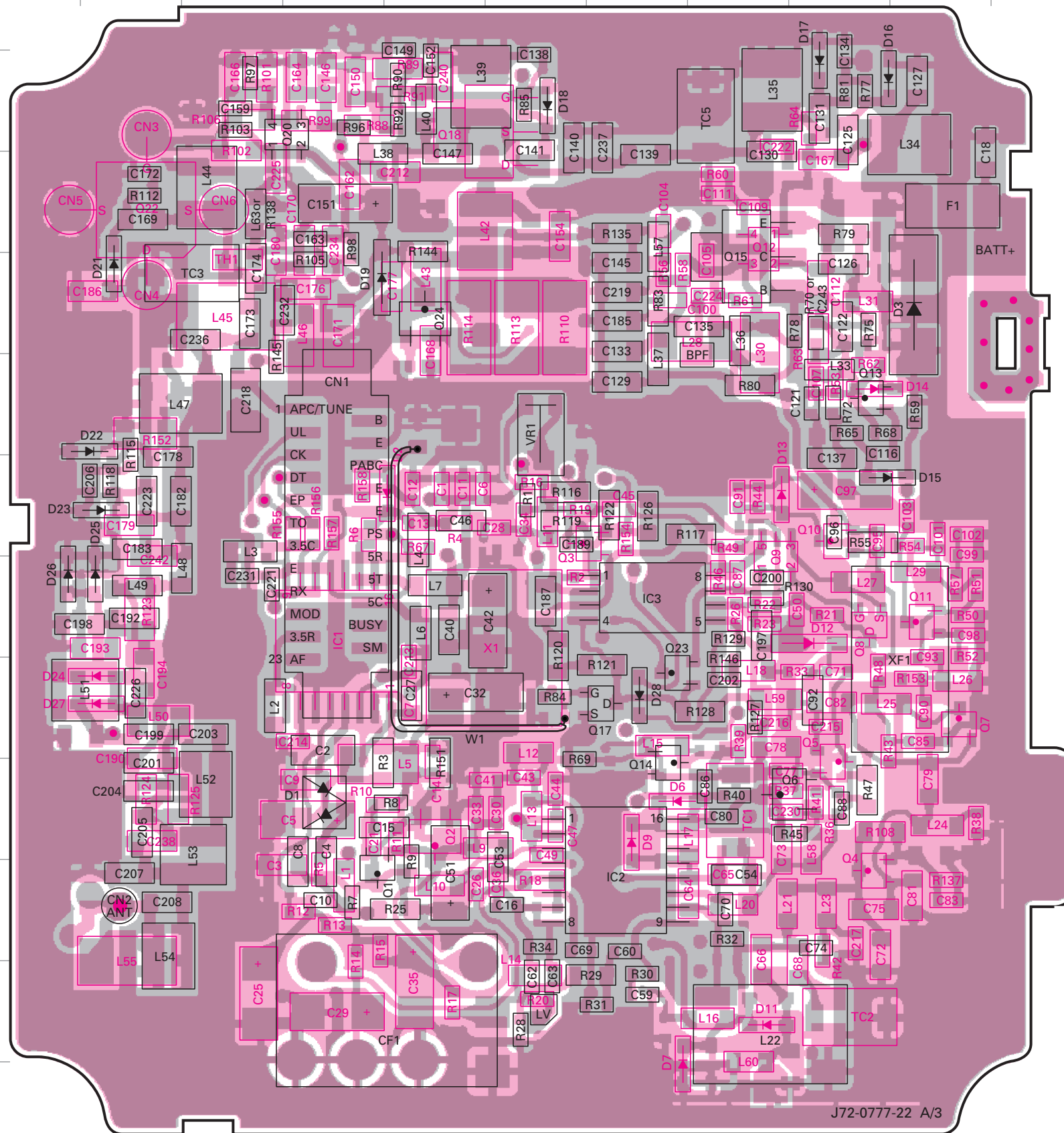

TX-RX UNIT (X57-6243-XX) (A/3)
Component side view+ Foil side view

Ref. No.	Address
IC1	8E
IC2	11H
IC3	8H
Q1	10E
Q2	10F
Q3	7H
Q4	11J
Q5	10J
Q6	10J
Q7	9K
Q8	8J
Q9	8I
Q10	7J
Q11	8K
Q12	5I
Q13	6J
Q14	10H
Q15	5I
Q17	9H
Q18	3G
Q20	3E
Q21	5G
Q22	4C
Q23	9H
Q24	5F
D1	10E
D2	7F
D3	5K
D6	12H
D7	13H
D9	11I
D11	12I
D12	10H
D13	7I
D14	6J
D15	7J
D16	3K
D17	3J
D18	3G
D19	5E
D21	5C
D22	7C
D23	7C
D24	9C
D25	8C
D26	8B
D27	9C
D28	9H

R70	R84	R138	C243	L63	W1
C	YES	YES	NO	NO	YES
C4	NO	NO	YES	YES	NO

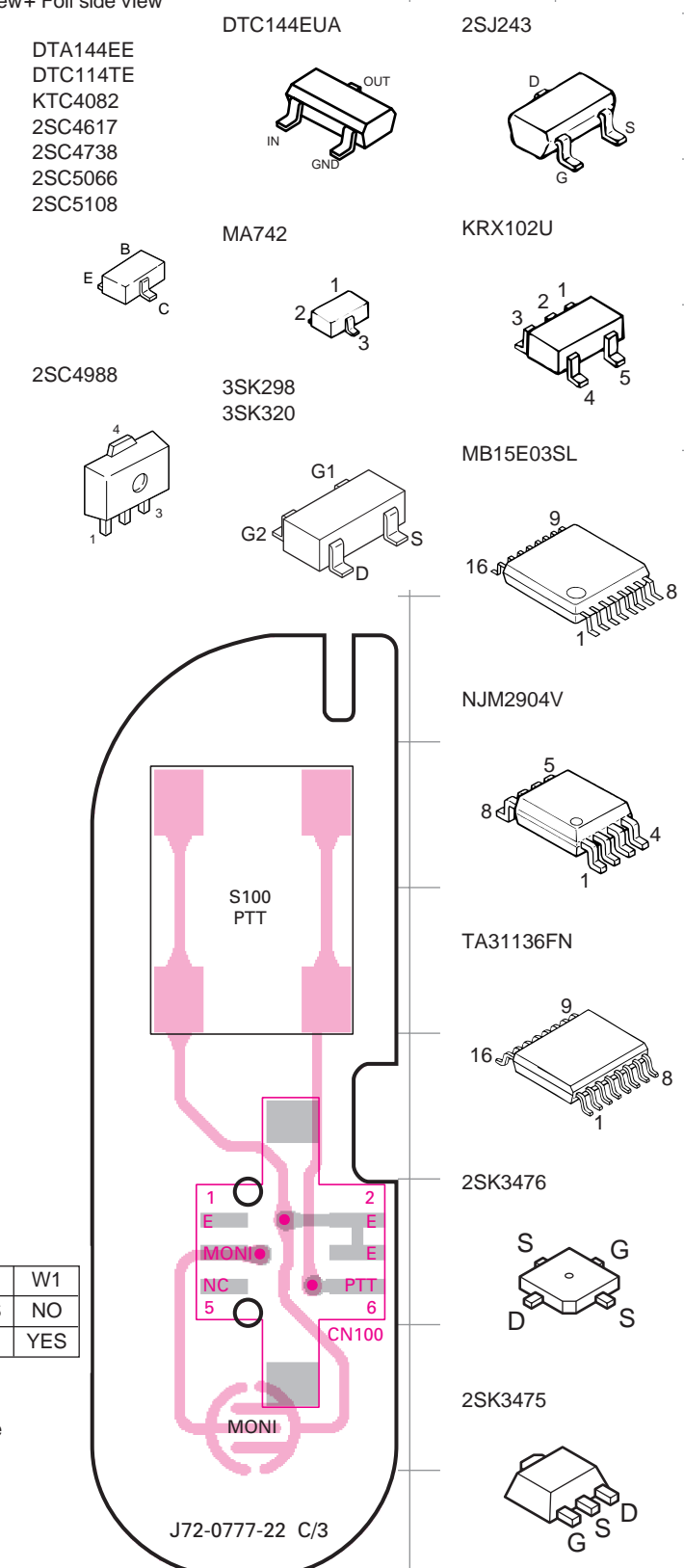
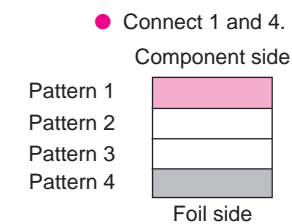

DTC144EUA

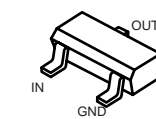

2SJ243

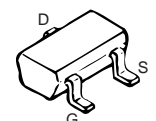

DTA144EE
DTC114TE
KTC4082
2SC4617
2SC4738
2SC5066
2SC5108

MA742

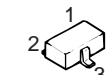

KRX102U

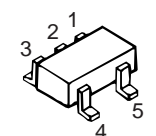

2SC4988

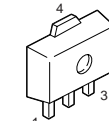

3SK298
3SK320

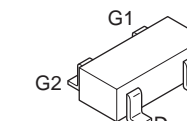

MB15E03SL

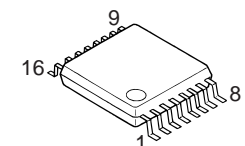

NJM2904V

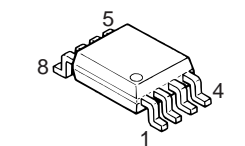

TA31136FN

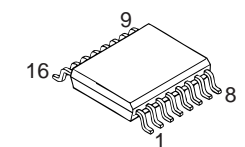

2SK3476

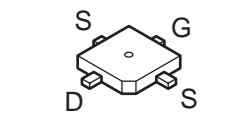

2SK3475

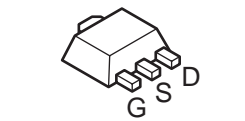

TK-3118 PC BOARD VIEW / PC 板视图

TX-RX UNIT (X57-6243-XX) -00:C -01:C4 Component side view

TX-RX UNIT (X57-6243-XX) (B/3)
Component side view

Ref. No.	Address
IC300	7I
IC302	10G
IC303	5E
IC304	6E
IC306	3G
Q303	7G
Q315	12E
Q316	5F
Q317	10H
Q318	10F
Q320	10J
Q324	11I
D304	3M
D305	13M
D309	12H

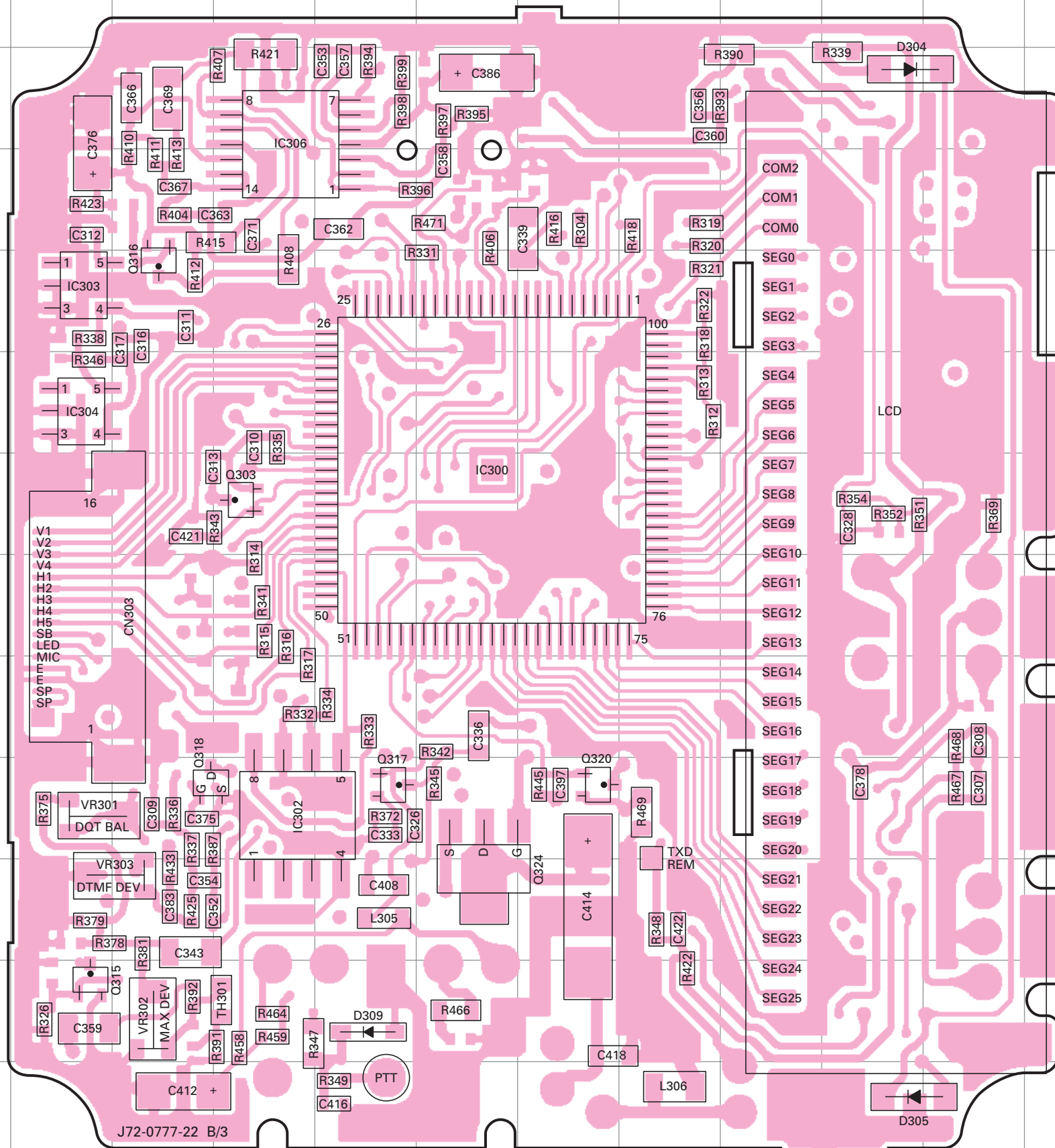

DTA144EE
DTC114EE
DTC114YE
DTC144EE
2SC4738

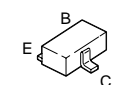

AT24C16N-10SI

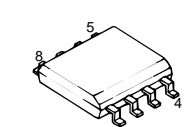

NJM2902V

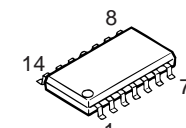

2SK1588

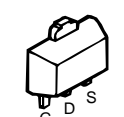

24LC16BT-I/SN

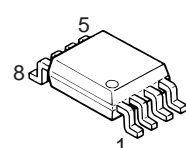

2SK1824

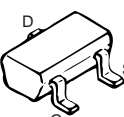

M38267M8L271GP

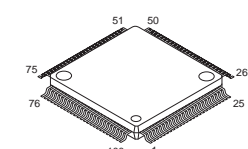

PST9124NR
PST9145NR

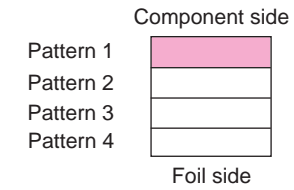
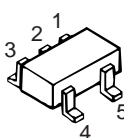

TK-3118 PC BOARD VIEW / PC 板视图

TX-RX UNIT (X57-6243-XX) -00:C -01:C4 Component side view + Foil side view

TX-RX UNIT (X57-6243-XX) (B/3)
Component side view+ Foil side view

Ref. No.	Address
IC300	6H
IC301	4E
IC302	10F
IC303	5D
IC304	6D
IC305	6L
IC306	3F
IC307	3K
IC308	10E
IC309	10I
Q300	9L
Q301	9L
Q302	11L
Q303	7F
Q304	5K
Q305	6H
Q306	7H
Q307	5H
Q308	6I
Q309	7F
Q310	7J
Q311	6J
Q312	5G
Q313	4M
Q314	3L
Q315	11D
Q316	4E
Q317	9G
Q318	9E
Q319	7F
Q320	9I
Q321	8J
Q322	10F
Q323	8I
Q324	10H
Q325	8H
D300	9M
D301	8I
D302	6L
D304	3L
D305	12L
D306	4J
D307	8F
D308	9F
D309	12G
D313	9M

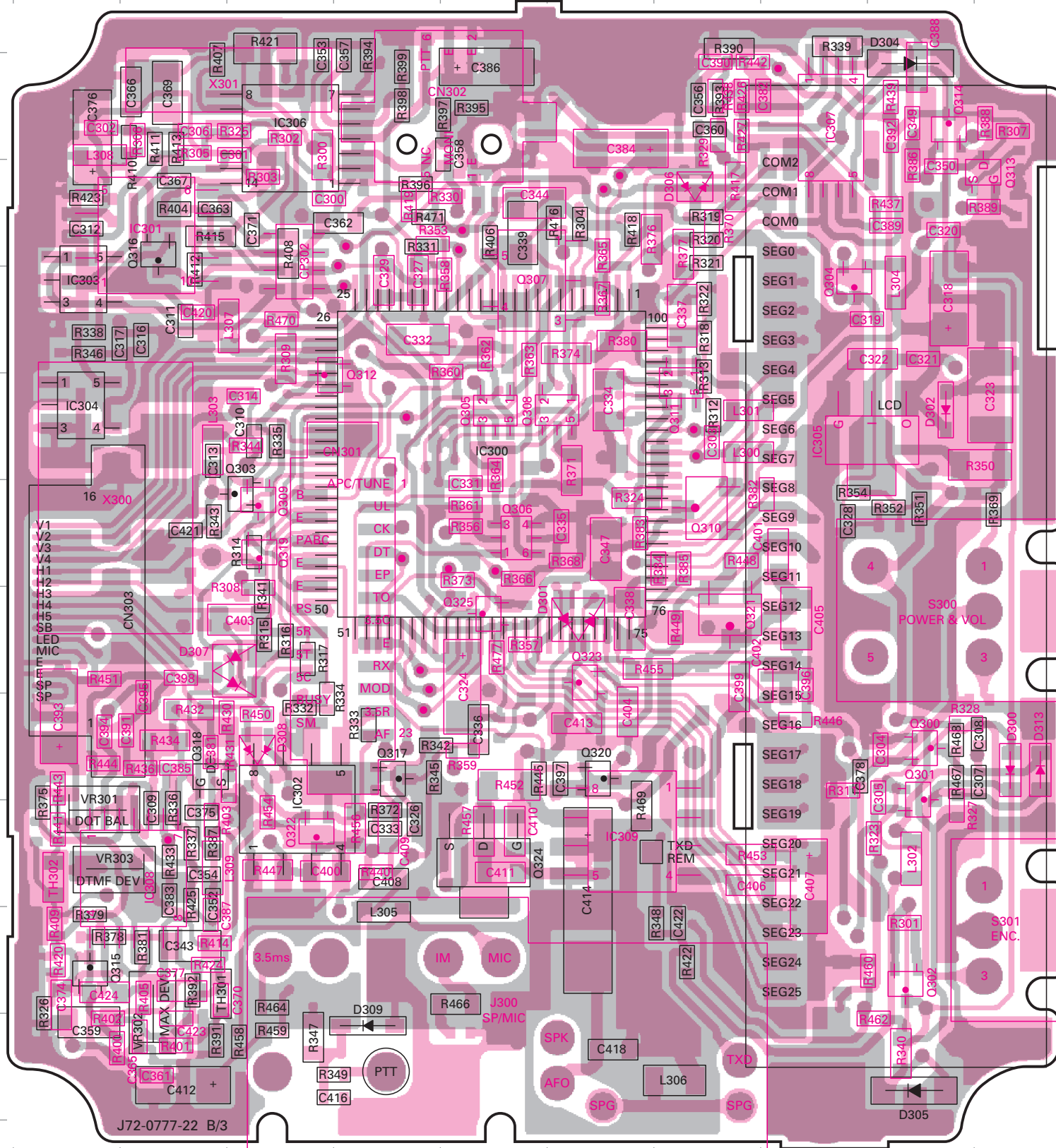

- DTA123JE
- DTA144EE
- DTC114EE
- DTC114YE
- DTC144EE
- 2SC4617
- 2SC4738

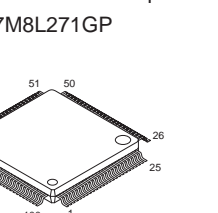
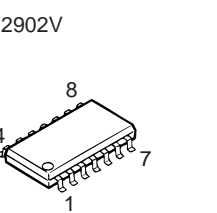
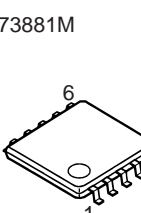
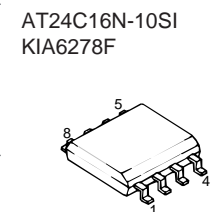
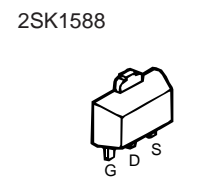
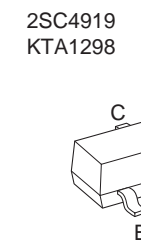
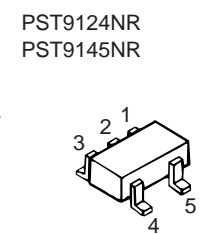
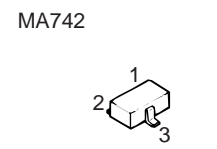
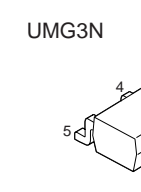
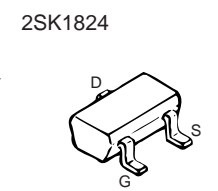
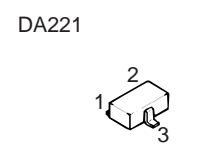
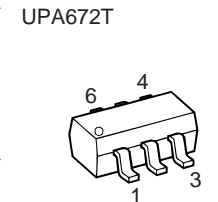
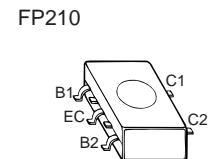

SCHEMATIC DIAGRAM / 原理图 TK-3118

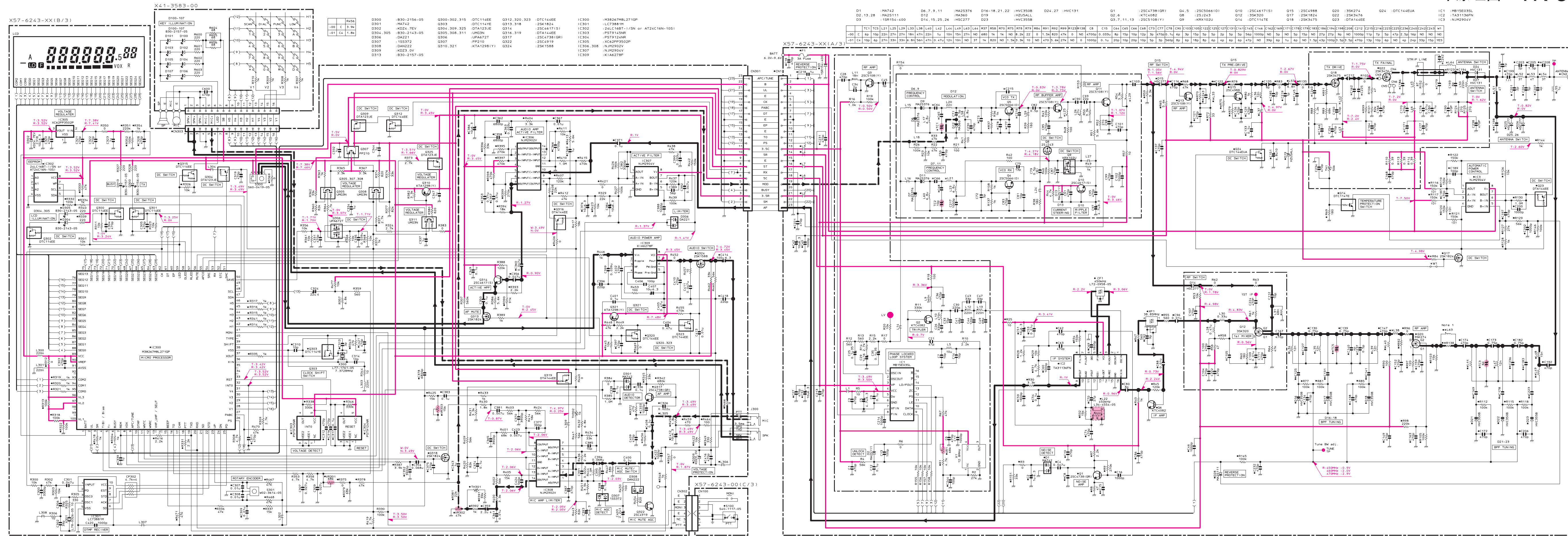

X57-6243-XX(B/3)

X57-6243-XX(A/3)

IC300 : M38267M8L271GP
 IC301 : LC73881M
 IC302 : 2ALC16BT-1/5N of AT24C16N-10S1
 IC303 : PS79145NR
 IC304 : PS79124NR
 IC305 : XC62PR3502P
 IC306 : NJM2902V
 IC307 : NJM2904V
 IC309 : KIA6278F

D1	:MA742	D6	:7.9.11	:MA25376	D16-18	:21.22	:HVC350B	D24	:27	:HVC131	G1	:25C4738(GR)	G4	:25C5066(O)	G10	:25C4617(S)	G15	:25C4988	G20	:35K274	G24	:DTC144EUA	IC1	:MB15E03SL
D2	:13.28	D7	:MA2511	:MA360	D19	:47	:HVC350B	D25	:27	:HVC131	G2	:KT4082	G8	:25J243	G12	:35K320	G17	:25K1824	G22	:25K3476	G26	:DTC144EUA	IC2	:TAS138FN
D3	:15R154-400	D8	:15.25.26	:HSC277	D23	:47	:HVC350B	D26	:27	:HVC131	G3	:15R154-400	G9	:KRX102U	G14	:DTC114TE	G18	:25K3475	G23	:DTC144EE	IC3	:NJM2904V		

IC302 : 2ALC16BT-1/5N of AT24C16N-10S1
 IC303 : PS79145NR
 IC304 : PS79124NR
 IC305 : XC62PR3502P
 IC306 : NJM2902V
 IC307 : NJM2904V
 IC309 : KIA6278F

IC300 : M38267M8L271GP
 IC301 : LC73881M
 IC302 : 2ALC16BT-1/5N of AT24C16N-10S1
 IC303 : PS79145NR
 IC304 : PS79124NR
 IC305 : XC62PR3502P
 IC306 : NJM2902V
 IC307 : NJM2904V
 IC309 : KIA6278F

IC300 : M38267M8L271GP
 IC301 : LC73881M
 IC302 : 2ALC16BT-1/5N of AT24C16N-10S1
 IC303 : PS79145NR
 IC304 : PS79124NR
 IC305 : XC62PR3502P
 IC306 : NJM2902V
 IC307 : NJM2904V
 IC309 : KIA6278F

IC300 : M38267M8L271GP
 IC301 : LC73881M
 IC302 : 2ALC16BT-1/5N of AT24C16N-10S1
 IC303 : PS79145NR
 IC304 : PS79124NR
 IC305 : XC62PR3502P
 IC306 : NJM2902V
 IC307 : NJM2904V
 IC309 : KIA6278F

IC300 : M38267M8L271GP
 IC301 : LC73881M
 IC302 : 2ALC16BT-1/5N of AT24C16N-10S1
 IC303 : PS79145NR
 IC304 : PS79124NR
 IC305 : XC62PR3502P
 IC306 : NJM2902V
 IC307 : NJM2904V
 IC309 : KIA6278F

IC300 : M38267M8L271GP
 IC301 : LC73881M
 IC302 : 2ALC16BT-1/5N of AT24C16N-10S1
 IC303 : PS79145NR
 IC304 : PS79124NR
 IC305 : XC62PR3502P
 IC306 : NJM2902V
 IC307 : NJM2904V
 IC309 : KIA6278F

IC300 : M38267M8L271GP
 IC301 : LC73881M
 IC302 : 2ALC16BT-1/5N of AT24C16N-10S1
 IC303 : PS79145NR
 IC304 : PS79124NR
 IC305 : XC62PR3502P
 IC306 : NJM2902V
 IC307 : NJM2904V
 IC309 : KIA6278F

IC300 : M38267M8L271GP
 IC301 : LC73881M
 IC302 : 2ALC16BT-1/5N of AT24C16N-10S1
 IC303 : PS79145NR
 IC304 : PS79124NR
 IC305 : XC62PR3502P
 IC306 : NJM2902V
 IC307 : NJM2904V
 IC309 : KIA6278F

IC300 : M38267M8L271GP
 IC301 : LC73881M
 IC302 : 2ALC16BT-1/5N of AT24C16N-10S1
 IC303 : PS79145NR
 IC304 : PS79124NR
 IC305 : XC62PR3502P
 IC306 : NJM2902V
 IC307 : NJM2904V
 IC309 : KIA6278F

IC300 : M38267M8L271GP
 IC301 : LC73881M
 IC302 : 2ALC16BT-1/5N of AT24C16N-10S1
 IC303 : PS79145NR
 IC304 : PS79124NR
 IC305 : XC62PR3502P
 IC306 : NJM2902V
 IC307 : NJM2904V
 IC309 : KIA6278F

IC300 : M38267M8L271GP
 IC301 : LC73881M
 IC302 : 2ALC16BT-1/5N of AT24C16N-10S1
 IC303 : PS79145NR
 IC304 : PS79124NR
 IC305 : XC62PR3502P
 IC306 : NJM2902V
 IC307 : NJM2904V
 IC309 : KIA6278F

IC300 : M38267M8L271GP
 IC301 : LC73881M
 IC302 : 2ALC16BT-1/5N of AT24C16N-10S1
 IC303 : PS79145NR
 IC304 : PS79124NR
 IC305 : XC62PR3502P
 IC306 : NJM2902V
 IC307 : NJM2904V
 IC309 : KIA6278F

IC300 : M38267M8L271GP
 IC301 : LC73881M
 IC302 : 2ALC16BT-1/5N of AT24C16N-10S1
 IC303 : PS79145NR
 IC304 : PS79124NR
 IC305 : XC62PR3502P
 IC306 : NJM2902V
 IC307 : NJM2904V
 IC309 : KIA6278F

IC300 : M38267M8L271GP
 IC301 : LC73881M
 IC302 : 2ALC16BT-1/5N of AT24C16N-10S1
 IC303 : PS79145NR
 IC304 : PS79124NR
 IC305 : XC62PR3502P
 IC306 : NJM2902V
 IC307 : NJM2904V
 IC309 : KIA6278F

IC300 : M38267M8L271GP
 IC301 : LC73881M
 IC302 : 2ALC16BT-1/5N of AT24C16N-10S1
 IC303 : PS79145NR
 IC304 : PS79124NR
 IC305 : XC62PR3502P
 IC306 : NJM2902V
 IC307 : NJM2904V
 IC309 : KIA6278F

IC300 : M38267M8L271GP
 IC301 : LC73881M
 IC302 : 2ALC16BT-1/5N of AT24C16N-10S1
 IC303 : PS79145NR
 IC304 : PS79124NR
 IC305 : XC62PR3502P
 IC306 : NJM2902V
 IC307 : NJM2904V
 IC309 : KIA6278F

IC300 : M38267M8L271GP
 IC301 : LC73881M
 IC302 : 2ALC16BT-1/5N of AT24C16N-10S1
 IC303 : PS79145NR
 IC304 : PS79124NR
 IC305 : XC62PR3502P
 IC306 : NJM2902V
 IC307 : NJM2904V
 IC309 : KIA6278F

IC300 : M38267M8L271GP
 IC301 : LC73881M
 IC302 : 2ALC16BT-1/5N of AT24C16N-10S1
 IC303 : PS79145NR
 IC304 : PS79124NR
 IC305 : XC62PR3502P
 IC306 : NJM2902V
 IC307 : NJM2904V
 IC309 : KIA6278F

IC300 : M38267M8L271GP
 IC301 : LC73881M
 IC302 : 2ALC16BT-1/5N of AT24C16N-10S1
 IC303 : PS79145NR
 IC304 : PS79124NR
 IC305 : XC62PR3502P
 IC306 : NJM2902V
 IC307 : NJM2904V
 IC309 : KIA6278F

IC300 : M38267M8L271GP
 IC301 : LC73881M
 IC302 : 2ALC16BT-1/5N of AT24C16N-10S1
 IC303 : PS79145NR
 IC304 : PS79124NR
 IC305 : XC62PR3502P
 IC306 : NJM2902V
 IC307 : NJM2904V
 IC309 : KIA6278F

IC300 : M38267M8L271GP
 IC301 : LC73881M
 IC302 : 2ALC16BT-1/5N of AT24C16N-10S1
 IC303 : PS79145NR
 IC304 : PS79124NR
 IC305 : XC62PR3502P
 IC306 : NJM2902V
 IC307 : NJM2904V
 IC309 : KIA6278F

IC300 : M38267M8L271GP
 IC301 : LC73881M
 IC302 : 2ALC16BT-1/5N of AT24C16N-10S1
 IC303 : PS79145NR
 IC304 : PS79124NR
 IC305 : XC62PR3502P
 IC306 : NJM2902V
 IC307 : NJM2904V
 IC309 : KIA6278F

IC300 : M38267M8L271GP
 IC301 : LC73881M
 IC302 : 2ALC16BT-1/5N of AT24C16N-10S1
 IC303 : PS79145NR
 IC304 : PS79124NR
 IC305 : XC62PR3502P
 IC306 : NJM2902V
 IC307 : NJM2904V
 IC309 : KIA6278F

IC300 : M38267M8L271GP
 IC301 : LC73881M
 IC302 : 2ALC16BT-1/5N of AT24C16N-10S1
 IC303 : PS79145NR
 IC304 : PS79124NR
 IC305 : XC62PR3502P
 IC306 : NJM2902V
 IC307 : NJM2904V
 IC309 : KIA6278F

IC300 : M38267M8L271GP
 IC301 : LC73881M
 IC302 : 2ALC16BT-1/5N of AT24C16N-10S1
 IC303 : PS79145NR
 IC304 : PS79124NR
 IC305 : XC62PR3502P
 IC306 : NJM2902V
 IC307 : NJM2904V
 IC309 : KIA6278F

IC300 : M38267M8L271GP
 IC301 : LC73881M
 IC302 : 2ALC16BT-1/5N of AT24C16N-10S1
 IC303 : PS79145NR
 IC304 : PS79124NR
 IC305 : XC62PR3502P
 IC306 : NJM2902V
 IC307 : NJM2904V
 IC309 : KIA6278F

IC300 : M38267M8L271GP
 IC301 : LC73881M
 IC302 : 2ALC16BT-1/5N of AT24C16N-10S1
 IC303 : PS79145NR
 IC304 : PS79124NR
 IC305 : XC62PR3502P
 IC306 : NJM2902V
 IC307 : NJM2904V
 IC309 : KIA6278F

Note: Component marked with a dot (•) are parts of pattern.

TK-3118 TK-3118

BLOCK DIAGRAM / 方块图

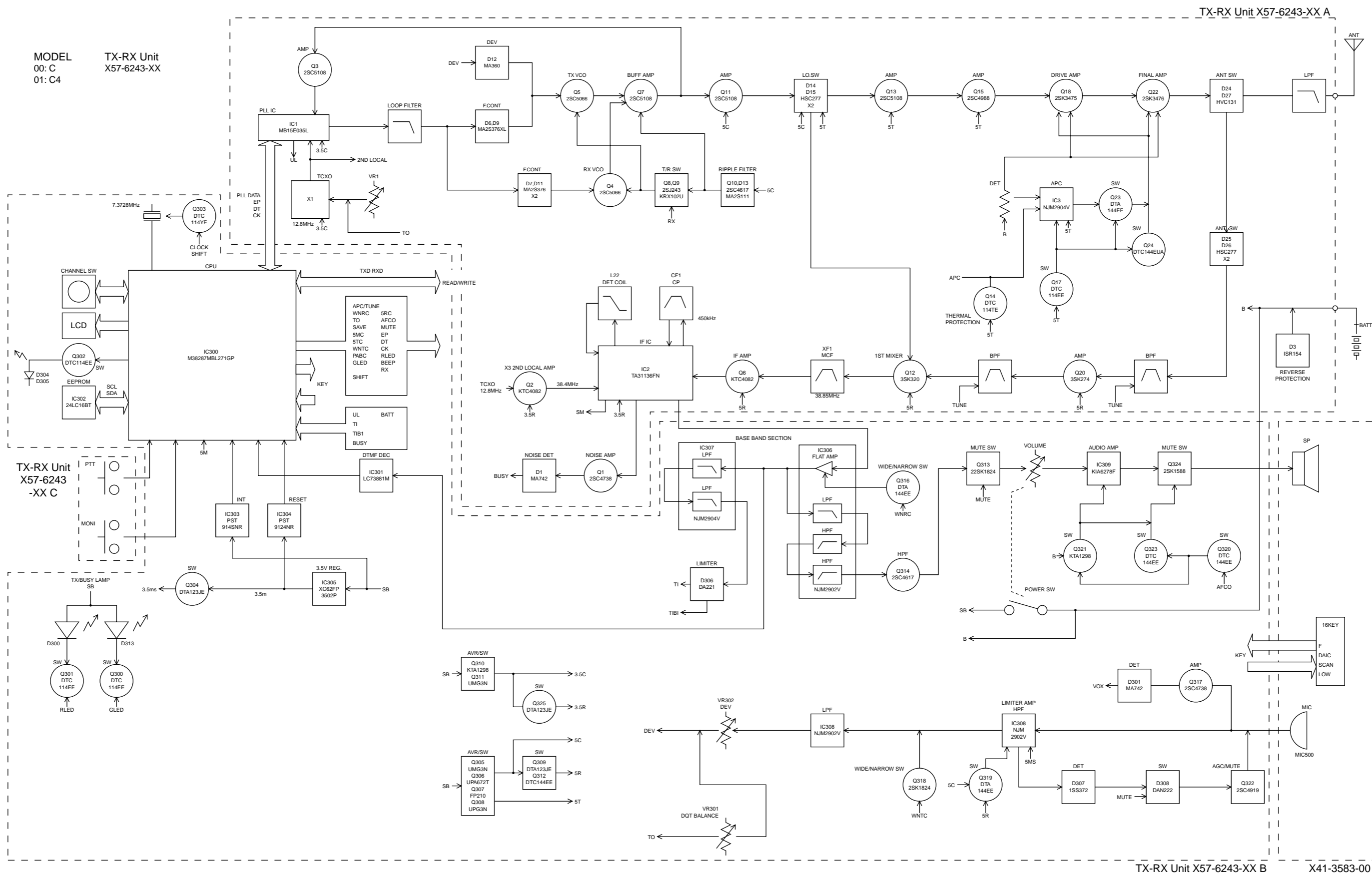

LEVEL DIAGRAM / 电平图

BC-20 / PB-40 / PB-41 / BT-12

RX section

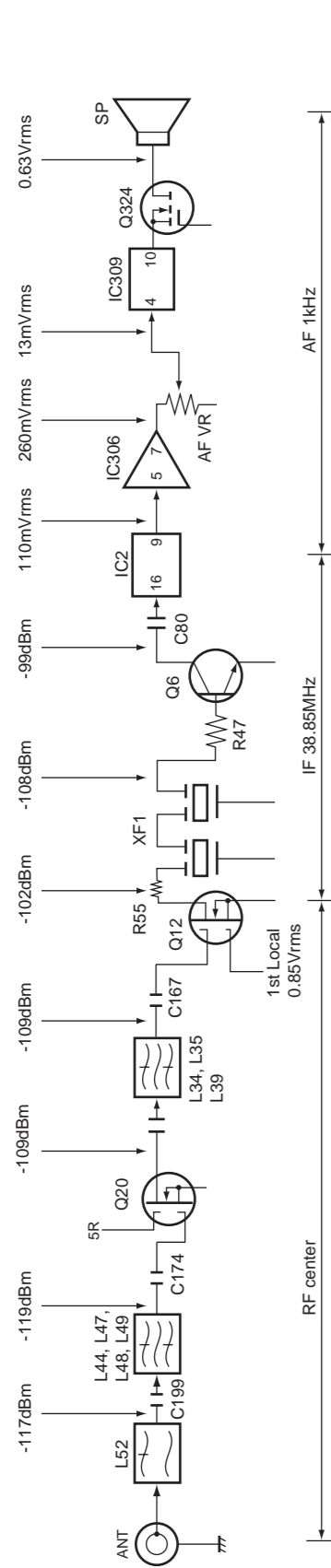

Modulate the AF level with a frequency of 1kHz and deviation of 1.5kHz (Narrow), 3kHz (Wide). Then take the signal from the signal generator output when set to -53dBm and obtain the level shown on an AF VTVM when the AF output has been adjusted to 0.63Vrms with the AF vol.

SG output level for obtaining 12dB / SINAD when injected to each point through a 470pF coupling capacitor. Measure the 1st Local level on a RF VTVM.

TX section

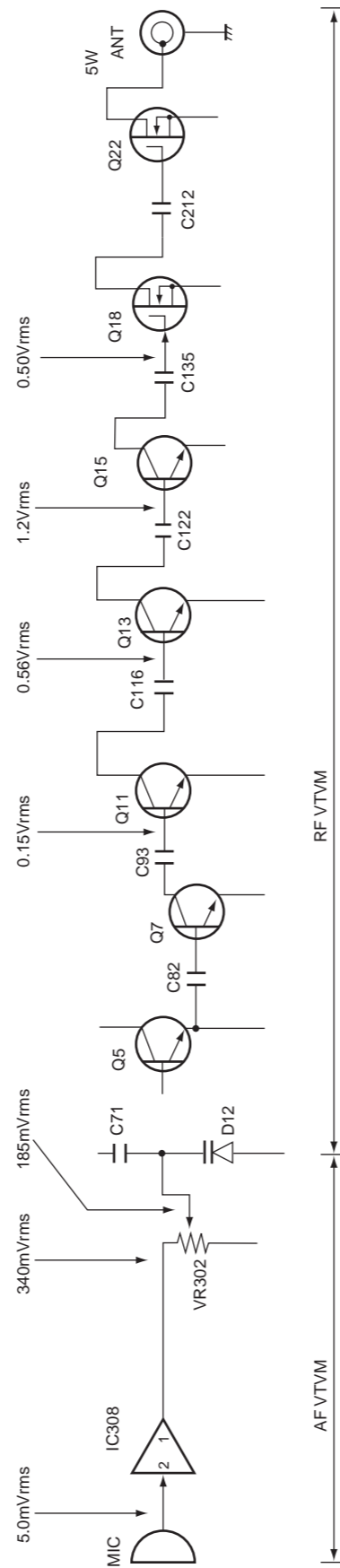

Measure the audio frequency on an AF VTVM and radio frequency on a RF VTVM at high impedance. Set the MIC input to obtain a modulation factor of 60% with the transmit frequency at center and a modulation frequency of 1kHz.

BC-20 RAPID CHARGER



PB-40 (Ni-MH) STANDARD BATTERY PACK



PB-41 (Ni-MH) LONG LIFE BATTERY PACK



BT-12 BATTERY CASE



SPECIFICATIONS

Voltage	: 7.2V
Battery Capacity	: 600mAh
Charging time	: approximately 60 minutes

SPECIFICATIONS

Voltage	: 7.2V
Battery Capacity	: 1000mAh
Charging time	: approximately 100 minutes

AA Battery X 5

SPECIFICATIONS

General

Frequency Range	C : 450~470MHz, C4 : 400~420MHz
Number of channels	Max. 50
Channel Spacing	25kHz (Wide) 12.5kHz (Narrow)
PLL Channel Stepping	5kHz, 6.25kHz
Operating Voltage	7.5 VDC \pm 20%
Battery Life	More than 5 hours at 5 watts (5-5-90 duty cycle with PB-40 battery) More than 8 hours at 5 watts (5-5-90 duty cycle with PB-41 battery)
Operating Temperature range	-20°C to +60°C
Dimensions and Weight	
With PB-40 (7.2V 600mAh battery)	56W x 116H x 24.3D mm 259g
With PB-41 (7.2V 1100mAh battery)	56W x 129.2H x 24.3D mm 301g

Receiver (Measurements made per EIA standard EIA-RS316B)

Sensitivity	
EIA 12dB SINAD	0.25 μ V (Wide)/0.28 μ V (Narrow)
Selectivity	60dB (Wide)/50dB (Narrow)
Intermodulation	60dB (Wide)/55dB (Narrow)
Spurious response	60dB
Audio Power Output	500mW
Frequency Stability	\pm 2.5ppm
Channel Frequency Spread	20MHz

Transmitter (Measurements made per EIA standard EIA-RS 316B)

RF Power output	5W/2W
Spurious and Harmonics	60dB
Modulation	16K0F3E (Wide)/8K50F3E (Narrow)
FM Noise	45dB (Wide)/40dB (Narrow)
Audio Distortion	Less than 5%
Frequency Stability	\pm 2.5ppm
Channel Frequency Spread	20MHz

概述

频率范围	C : 450~470MHz, C4 : 400~420MHz
信道数量	最多 50 个
信道间距	25kHz (宽) 12.5kHz (窄)
锁相环电路步进频率	5kHz, 6.25kHz
工作电压	7.5V 直流 \pm 20%
电池寿命	5W 时长于 5 个小时 (使用 PB-40 电池 5-5-90 工作周期) 5W 时长于 8 个小时 (使用 PB-41 电池 5-5-90 工作周期)
工作温度范围	-20°C 到 +60°C
尺寸和重量	
带有 PB-40 (7.2V 600mAh 电池)	56 宽 \times 116 高 \times 24.3 长毫米 259g
带有 PB-41 (7.2V 1100mAh 电池)	56 宽 \times 129.2 高 \times 24.3 长毫米 301g

接收部 (以每 EIA 标准 EIA-RS316BA 进行测量)

灵敏度	
EIA 12dB SINAD	0.25 μ V (宽) / 0.28 μ V (窄)
选择性	60dB (宽) / 50dB (窄)
互调	60dB (宽) / 55dB (窄)
假信号响应	60dB
音频功率输出	500mW
频率稳定性	\pm 2.5ppm
信道频率扩展	20MHz

发射部 (以每 EIA 标准 EIA-316BA 进行测量)

射频功率输出	5W/2W
寄生和谐波	60dB
调制	16K0F3E (宽) / 8K50F3E (窄)
频率调制噪声	45dB (宽) / 40dB (窄)
音频失真	低于 5%
频率稳定性	\pm 2.5ppm
信道频率扩展	20MHz

KENWOOD CORPORATION

14-6, Dogenzaka 1-chome, Shibuya-ku, Tokyo 150-8501, Japan

KENWOOD SERVICE CORPORATION

P.O. BOX 22745, 2201 East Dominguez Street, Long Beach, CA 90801-5745, U.S.A.

KENWOOD ELECTRONICS CANADA INC.

6070 Kestrel Road, Mississauga, Ontario, Canada L5T 1S8

KENWOOD ELECTRONICS DEUTSCHLAND GMBH

Rembrücker Str. 15, 63150 Heusenstamm, Germany

KENWOOD ELECTRONICS BELGIUM N.V.

Leuvensesteenweg 248 J, 1800 Vilvoorde, Belgium

KENWOOD ELECTRONICS FRANCE S.A.

13, Boulevard Ney, 75018 Paris, France

KENWOOD ELECTRONICS U.K. LIMITED

KENWOOD House, Dwight Road, Watford, Herts., WD1 8EB United Kingdom

KENWOOD ELECTRONICS EUROPE B.V.

Amsterdamsseweg 37, 1422 AC Uithoorn, The Netherlands

KENWOOD ELECTRONICS ITALIA S.p.A.

Via G. Sirtori, 7/9 20129 Milano, Italy

KENWOOD IBERICA S.A.

Bolivia, 239-08020 Barcelona, Spain

KENWOOD ELECTRONICS AUSTRALIA PTY. LTD.

(A.C.N. 001 499 074)

16 Giffnock Avenue, Centrecourt Estate, North Ryde, N.S.W. 2113, Australia

KENWOOD ELECTRONICS (HONG KONG) LTD.

Unit 3712-3724, Level 37, Tower one Metroplaza, 223 Hing Fong Road, Kwai Fong, N.T., Hong Kong

KENWOOD ELECTRONICS TECHNOLOGIES(S) PTE LTD.

Sales Marketing Division

1 Ang Mo Kio Street 63, Singapore 569110

